



FEB 

Scheda tecnica **SERIE 7E00**

Valvole e detentori per radiatore

Sommario

PRESENTAZIONE	3
VANTAGGI	3
CAMPI DI APPLICAZIONI E PRESTAZIONI	3
COMPONENTI E MATERIALI VALVOLA	4
COMPONENTI E MATERIALI DETENTORE	6
DIAGRAMMA PERDITE DI CARICO	8
NORMATIVE	9
CERTIFICAZIONI	9

SERIE 7E00
Valvole e detentori per radiatore

FEB





PRESENTAZIONE

Le valvole sono dispositivi di intercettazione di fluidi come acqua calda e fredda negli impianti di riscaldamento e raffreddamento.

Le valvole sono disponibili in tutte le figure, con attacchi filettati femmina o Eurocono. Oltre alla valvola di ingresso al corpo scaldante, è opportuno installare in uscita un detentore con funzioni di intercettazione e regolazione. I detentori General Fittings hanno l'interasse uguale alla corrispondente valvola di ingresso.

Le linee lisce ed arrotondate della serie 7E00 si presentano esteticamente gradevoli, grazie all'utilizzo di una manopola ad incastro. A livello tecnico la serie 7E00 presenta una chiusura a doppia tenuta, a garanzia di una maggior sicurezza. La chiusura è infatti sia tramite O-Ring che di tipo Metallo / Metallo.

VANTAGGI



-  Ampia gamma
-  Chiusura a doppia tenuta (O-Ring + metallo/metallo) per una maggiore sicurezza
-  Manopola ad incastro
-  Materie prime impiegate di alta qualità [UBA LIST]



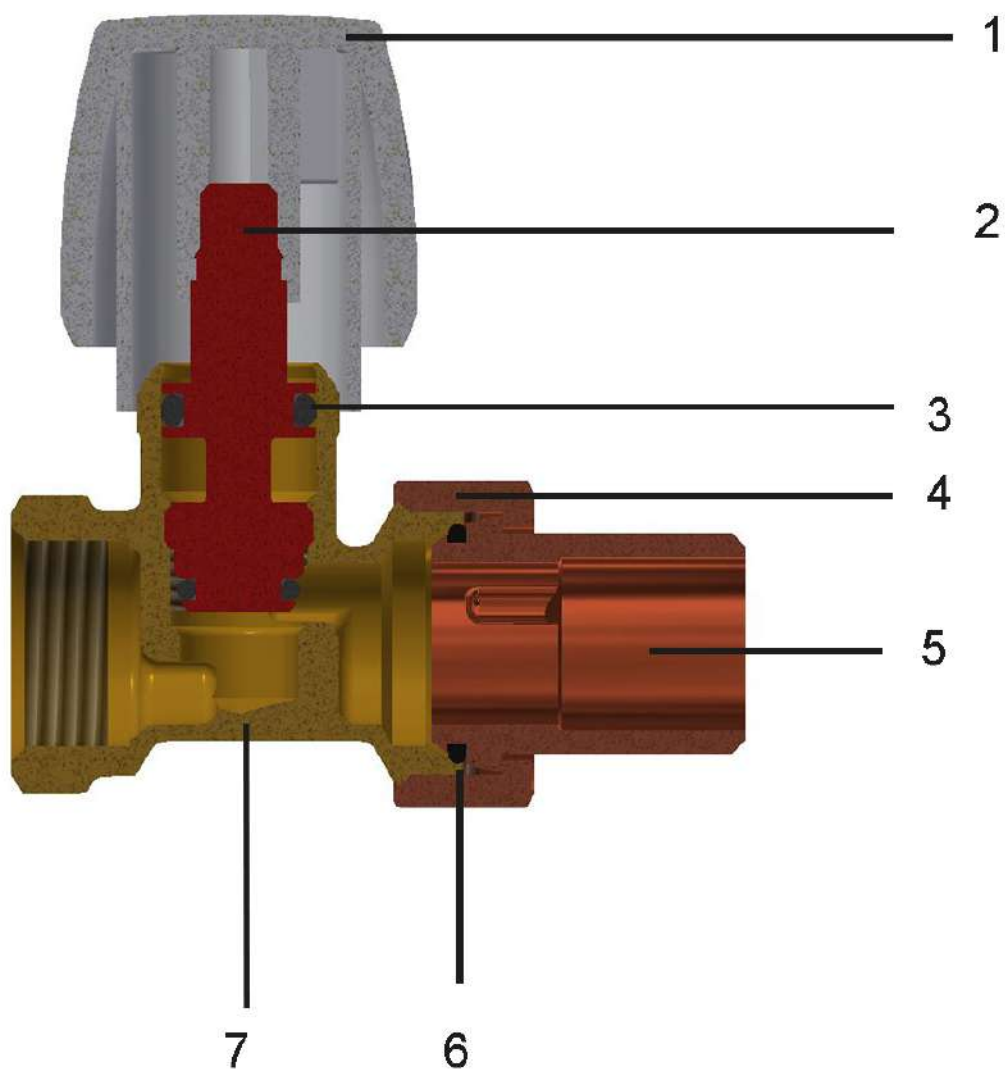

CAMPI DI APPLICAZIONI E PRESTAZIONI

APPLICAZIONI	T. min.	T. max	Press.max	Press.diff.
 radiatori	-20°C	+100°C	10 bar	1 bar
-20°C: solo con liquido antigelo, glicole, in % max del 30%				

COMPONENTI E MATERIALI VALVOLA





LEGENDA		COMPONENTI	MATERIALI
	1	Manopola	ABS bianco RAL 9010
	2	Asta	CW617N - UNI EN 12164
	3	O-Ring asta/otturatore	Elastomero

LEGENDA		COMPONENTI	MATERIALI
	4	Dado	CW617N - UNI EN 12165
	5	Codolo	CW617N - UNI EN 12164
	6	O-Ring codolo	Elastomero
	7	Corpo	CW617N - UNI EN 12165

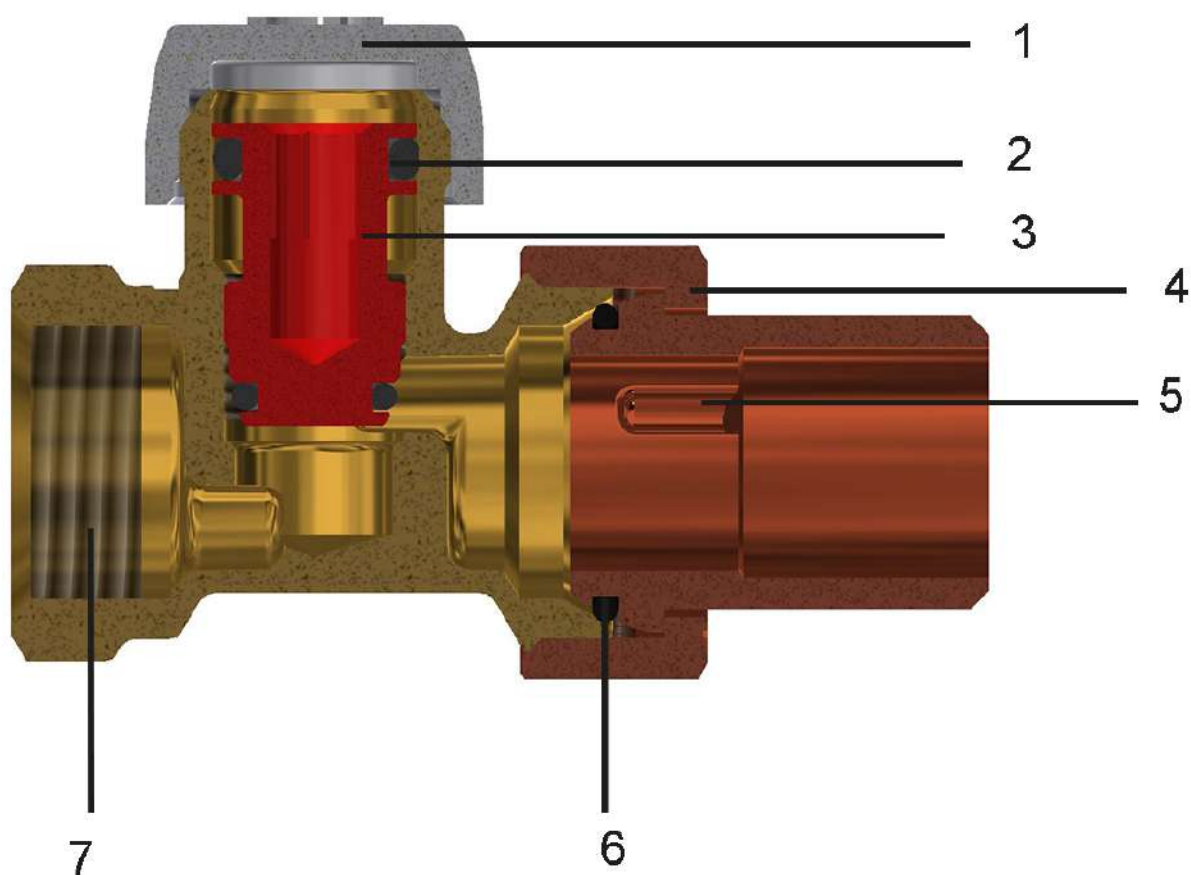
COMPONENTI E MATERIALI DETENTORE



LEGENDA		COMPONENTI	MATERIALI
	1	Manopola	ABS bianco RAL 9010
	2	O-Ring asta/otturatore	Elastomero
	3	Otturatore	CW617N - UNI EN 12164





LEGENDA		COMPONENTI	MATERIALI
	4	Dado	CW617N - UNI EN 12165
	5	Codolo	CW617N - UNI EN 12164
	6	O-Ring codolo	Elastomero
	7	Corpo	CW617N - UNI EN 12165

DIAGRAMMA PERDITE DI CARICO**Kv 1.25**

NORMATIVE

- UN EN ISO 228-1
Filettatura di tubazioni per accoppiamento non a tenuta sul filetto

CERTIFICAZIONI

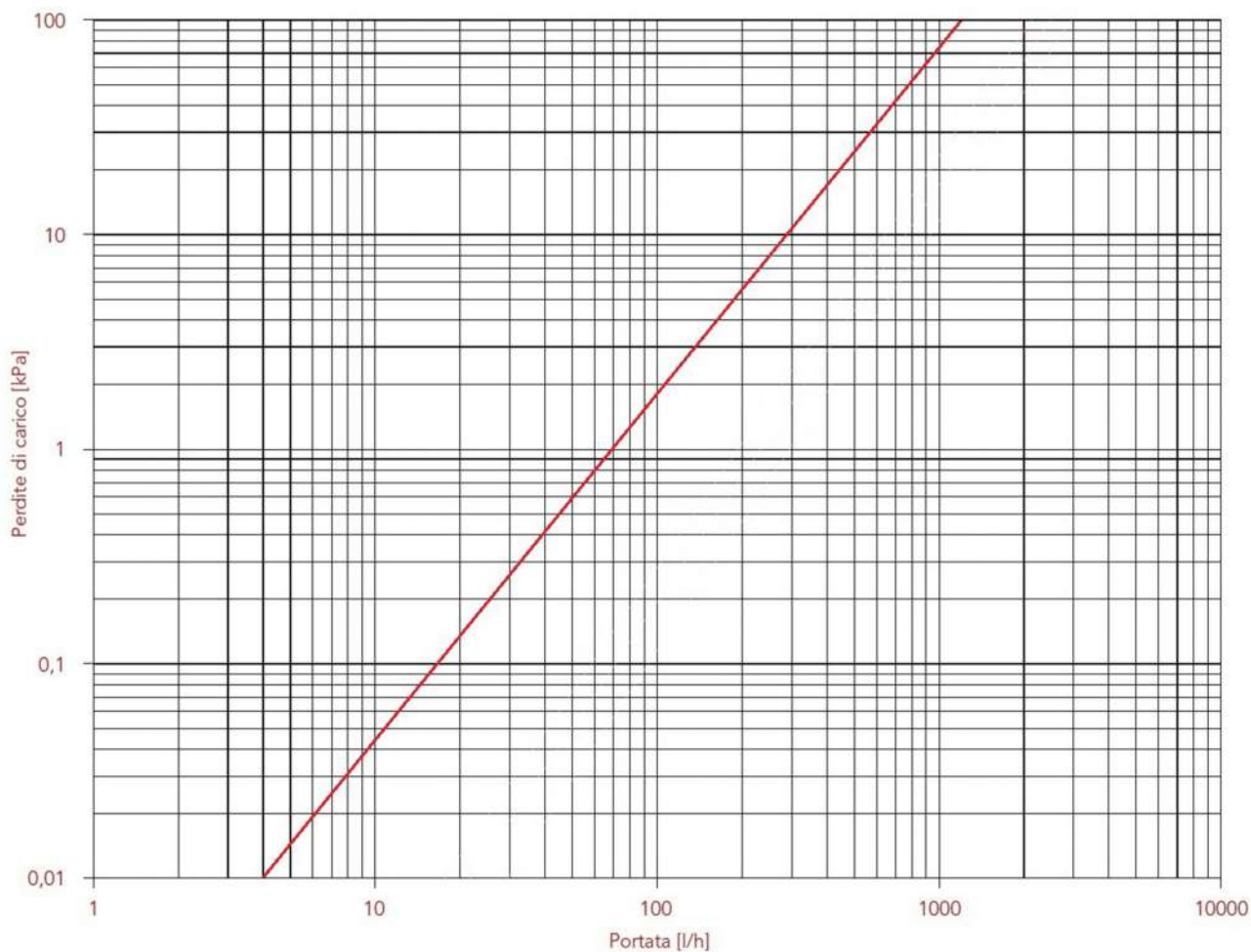
STATO	CERTIFICAZIONE	STATO	CERTIFICAZIONE	STATO	CERTIFICAZIONE
					
					



GENERAL FITTINGS SPA

Via Golgi 73/75, 25064 Gussago (BS) - ITALY

te. +39 030 3739017

www.generalfittings.it