

URANO 

Data sheet **LINE 5S00**

Multijaws press fittings

Contents

DESCRIPTION	3
ADVANTAGES	3
FIELDS OF APPLICATION	4
COMPONENTS AND MATERIALS	5
PRESSING PROFILES	6
REGULATIONS	6
CERTIFICATIONS	7
ASSEMBLY INSTRUCTIONS	8

LINE 5S00**Multijaws radial press fittings for
Pe-X/Al/Pe-X pipe****URANO** **DESCRIPTION**

Press fittings for multilayer pipe of LINE 5S00 have been designed and tested to be used with 6 different crimper profiles: TH, H, U, B, F, CH.

Fittings are suitable for cold or hot water supply for sanitary or heating systems, and for any kind of sanitary installation such as domestic, commercial, industry and farming and with non-aggressive fluids.

Fitting body is made of brass, while the sleeve is made of AISI 304 stainless steel.

The geometry of the fitting allows an excellent coupling between pipe and fitting after pressing and the plastic insulation ring windows allow to check the correct insertion of the pipe. Two O-rings guarantee the seal and reliability over time.









Plastic insulation ring prevents electrolytic corrosion

Since the connecting type is irreversible (it is not possible to disassemble), it is possible to place the fittings concealed, taking care of protecting it from non-suitable materials.

ADVANTAGES





- Multijaw: TH, H, U, B, F, CH
- Wide range
- Plastic insulation ring to prevent electrolytic corrosion, and with windows to check the correct insertion of pipe
- Double O-Ring
- DVGW certified
- Raw materials complying with UBA LIST
- ISO 7/1 threads
- Product traceability guaranteed by the date stamped on the body of the fitting
- Efficient installation: double wallplate elbow allows to make installations in series or rings for a better distribution and change of water

FIELDS OF APPLICATION

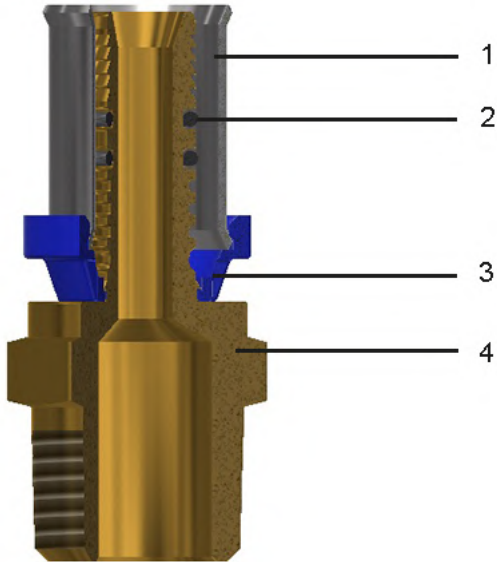
APPLICATIONS		T. min.	T. max	T. of the system	Max. pressure
	drinking water	-20°C	+120°C	-20°C/+95°C	10 bar (Ø40-50-63 max 6 bar)
	hot sanitary water	-20°C	+120°C	-20°C/+95°C	10 bar (Ø40-50-63 max 6 bar)
	cooling	-20°C	+120°C	-20°C/+95°C	10 bar (Ø40-50-63 max 6 bar)
	radiators	-20°C	+120°C	-20°C/+95°C	10 bar (Ø40-50-63 max 6 bar)
	floor heating	-20°C	+120°C	-20°C/+95°C	10 bar (Ø40-50-63 max 6 bar)
	irrigation	-20°C	+120°C	-20°C/+95°C	10 bar (Ø40-50-63 max 6 bar)
	compressed air	-20°C	+120°C	-20°C/+95°C	10 bar (Ø40-50-63 max 6 bar)
	-20°C: with the use of glycol in a maximum percentage of 30%				

COMPONENTS AND MATERIALS



LEGEND		COMPONENTS	MATERIALS
	1	Sleeve	Stainless steel - AISI 304
	2	O-Ring	Elastomer for drinking water
	3	Closing ring	Nylon
	4	Body	Brass CW617N/CW612N - UNI EN 12165

PRESSING PROFILES

∅	TH	H	U	B	F	CH
14x2.0	TH	H	U	-	-	-
16x2.0	TH	H	U	B	F	CH
18x2.0	TH	H	U	-	-	-
20x2.0	TH	H	U	B	F	CH
20x2.25	TH	H	U	-	-	-
25x2.5	TH	H	U	-	-	-
26x3.0	TH	H	-	B	F	CH
32x3.0	TH	H	U	B	F	-
40x3.5	TH	H	U	-	-	-
50x4.0	TH	H	U	-	-	-
63x4.5	TH	-	U	-	-	-

REGULATIONS

- ISO 21003-3

"Multilayer piping systems for hot and cold water supply installations inside building"

- 1254-7-8 REGULATION

Fittings comply with UNI EN 1254-7-8 law. Part 8: "Fittings with press ends for use with plastics and multilayer pipes".

- UNI EN 10226-1

Threads comply with UNI EN 10226-1 law: "Piping thread for coupling on the thread".

- D.M. 174 (06/04/2004)

Raw materials used are of high quality and comply with the Ministerial Decree N°174 dated 06/04/2004 concerning the materials and the items used in fixed installations for water collection, treatment and supply.

- Comply with 4MS, UBA List (BC group), DIN 50930/6 Dir. 2011/65/UE, 6C attachment III (RhOSII).

- Comply with DVGW W534

CERTIFICATIONS

COUNTRY	CERTIFICATION	COUNTRY	CERTIFICATION	COUNTRY	CERTIFICATION
					
					
					
					

ASSEMBLY INSTRUCTIONS

Cut the pipe perpendicularly to its axis using an appropriate pipe-cutting tool [code TT500.00].



Calibrate the pipe using special reamer [code CS50.00, MA00.90], removing possible residual chips. The pipe edge should be trimmed throughout the circumference.



Insert the pipe into the pipe holder until the pipe stops at the plastic ring. Check that the pipe is properly inserted and visible from all inspection windows.



Place the pressing jaws and operate the electric button of the pressing machine.
An improper placing of the jaws could damage the proper system functioning.

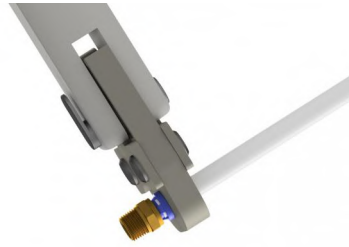



GENERAL FITTINGS SPA

Via Golgi 73/75, 25064 Gussago (BS) - ITALY

te. +39 030 3739017

www.generalfittings.it