



# WELCODOUAL

## Datasheet WELCODOUAL

Coplanar manifold with shut-off valves for recessed installation

# Contents

DESCRIPTION	3
ADVANTAGES	4
FIELDS OF APPLICATION	5
A WATER DISTRIBUTION SYSTEM IN JUST 8 CM	6
MAIN FEATURES	7
HYDRAULIC DYNAMICS	10
HYDRAULIC DISTRIBUTION	11
MANIFOLD INSPECTION AND VALVE OPERATION	12
INSTALLATION	16
GASKETS REPLACEMENT	18
DIMENSIONS	19

## Coplanar manifolds



## WELCODUAL

### DESCRIPTION

WELCODUAL is a brass coplanar manifold for the distribution of hot and cold water in sanitary plumbing systems, with built-in ball valves and with all the connections, head and side, coplanar, 3/4" M (Eurocone). WELCODUAL is produced in two models that differ only in the number of available connections:

- 2x2, a double coplanar manifold with two shut-off valves and three hot and cold water outlet connections;
- 4x4, a double coplanar manifold with two shut-off valves and five hot and cold water outlet connections.

The type of connections available means they can be connected to the WELCOFLEX multilayer pipe and also to other types of pipes, compatible with Eurocone couplings.

A PATENTED plastic case, an integral part of the system, which can be used in different ways, facilitates installation operations, allows the insertion of the manifold in thinner walls (7-8 cm), protects the manifold and fittings from direct contact with lime-based mortars (which can corrode brass) and allows partial or complete inspection.

## ADVANTAGES

- A water distribution system in just 8 CM: the small case adapts to new construction standards.
- Supplied complete with brackets for fixing to masonry.
- 3/4 EUROCONE connections on all couplings with the possibility of using both compression and press fittings.
- Front-mountable full-bore ball valves for easy maintenance.
- Alternate hot and cold outlets that allow the pipes not to cross.
- Possibility of installation both with inspection cover and totally hidden.
- Vertical and horizontal positioning, configurable from 3 to 5 outlets per temperature.
- Practical and safe construction of a water distribution system in which all its component parts are protected and isolated from direct contact with the masonry.
- Three different solutions for the control of the shut-off valves allow it to be adapted to any aesthetic need.

## FIELDS OF APPLICATION

APPLICATIONS		T. min.	T. max	Max. pressure
	drinking water	-20°C	+70°C	10 bar
	hot sanitary water	-20°C	+70°C	10 bar

## A WATER DISTRIBUTION SYSTEM IN JUST 8 CM

Cassetta spessore ridotto per  
installazione in 8cm  
Reduced thickness case for  
installation in 8cm

Rubinetti a sfera smontabili  
frontalmente per una manutenzione  
facilitata  
Front-mountable full bore ball valves  
for easy maintenance

Possibilità di installazione sia  
con coperchio di ispezione che  
totalmente nascosto  
Possibility of installation both  
with inspection cover and totally  
hidden



Connessioni 3/4 Eurocono su tutti  
gli stacchi  
3/4 eurocone connections on all  
couplings

Uscite calda e fredda alternata  
per non incrociare le tubazioni  
Alternate hot and cold outlets  
not to cross pipes

Posizionamento verticale ed  
orizzontale, configurabile da 3 a 5  
uscite di temperatura  
Vertical and horizontal  
positioning, configurable from 3  
to 5 outlets per temperature



## MAIN FEATURES

- WELCODUAL can be inserted in a vertical wall of only 8 cm, set into a case made of plastic with the possibility of inspecting only the parts that, over time, could deteriorate (e.g., seals or balls of the valves) or with full inspection of the entire manifold;
- limit heat loss and also attenuate the noise of running water, thanks to the protective plastic case;
- allow the two valves, incorporated in the manifold, to be operated directly by the user if necessary, even from the outside, without having to remove an inspection door;
- allow the construction of a system in which all its component parts are protected and isolated from direct contact with the masonry. The manifold and fittings are in fact protected inside the plastic case, the WELCOFLEX multi-layer pipe is generally thermally insulated with 6 mm of closed-cell polyethylene foam, and even the connection tee fittings that may be chased in can be protected by polyurethane half-shells;
- reduce pressure drops and an irrelevant heat exchange between hot and cold water inside the manifold;
- a special surface treatment (Teflon coating) on the ball in the valves prevents it from sticking, even after long periods of non-use, ensuring smooth water flows over time;
- to make it easier to identify (hot or cold?) the side couplings on the output connections of the manifold, they are stamped with a 'C' to indicate the hot path and 'F' for the cold path; in addition, to properly feed the manifold, the two valves have plastic protections of different colours. The hot water valve is red, the cold water valve is blue.

1. WELCODUAL manifold installed in a tiled wall, with a double rose in polished chrome ABS and the possibility of inspecting only the valves, which can be operated from the outside by means of chrome-plated knobs.

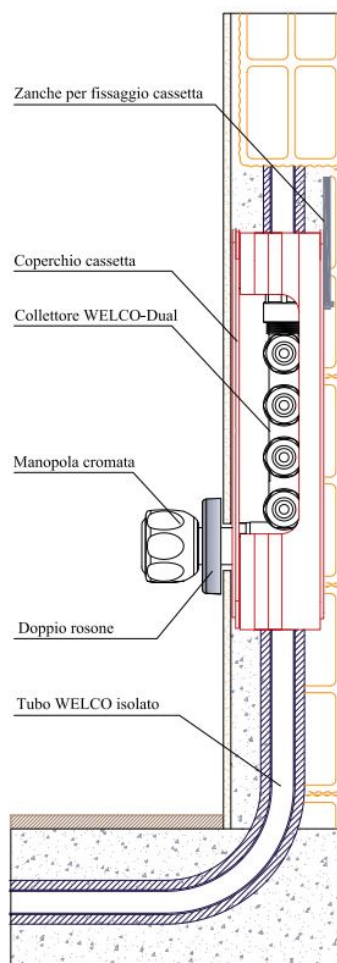



2. WELCO-Dual manifold installed in a tiled wall, with a light brown removable perforated door, and the ability to inspect the manifold and valves, which can be operated from the outside by means of chrome-plated knobs.

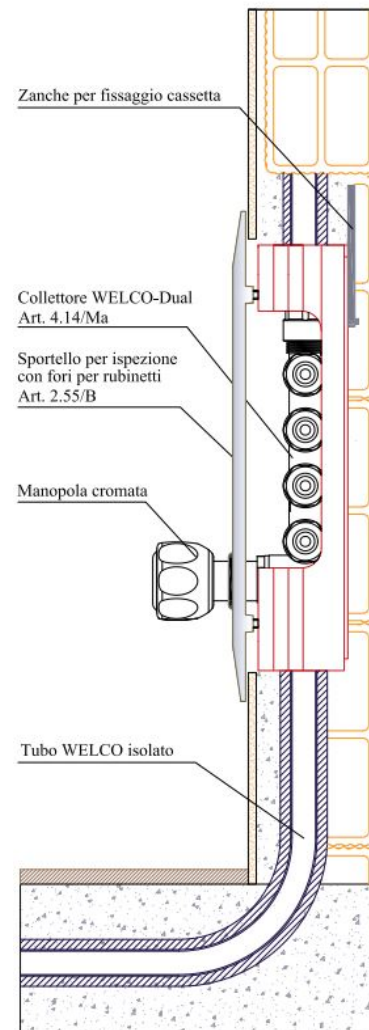

## HYDRAULIC DYNAMICS

The WELCODUAL manifold is used in sanitary systems. Its main hydraulic characteristics are as follows:

- Maximum operation temperature: 70°C
- Maximum operation pressure: 10 bar
- Flow coefficient Kv: 2.55 m<sup>3</sup>/h

With the valve fully open, the manifold has a Kv value = 2.55 m<sup>3</sup>/h; a pressure drop due to the inadvertent resistance of the ball valve plus the inadvertent resistance caused by flow deviation the lateral connections or by the reduction of passage in the head connections.

The total pressure drop caused by the manifold is compatible with the pressure usually available in most systems; with a flow rate of 0.72 m<sup>3</sup>/h (0.2 l/sec, the maximum flow required for a bathtub, for example), the pressure loss of the manifold alone will be:

$$DP = (Q/Kv)^2 = (0.72/2.55)^2 = 0.0797 \text{ bar} = 79.7 \text{ mbar} = 797 \text{ mm water}$$

To determine the minimum total pressure necessary upstream of the manifold, other values must also be known, such as length, unit pressure drop of the pipe, as well as the hydraulic characteristics of the valves used

## HYDRAULIC DISTRIBUTION

The system usually adopted with WELCODUAL is mainly of the manifold type, though it is also possible to use some branch connections. Use of the WELCODUAL manifold in the two available models makes differentiated solutions possible, with or without an inspection door.

If necessary, the user can also easily operate the shut-off valves, which are incorporated into the manifold. The WELCODUAL manifold can therefore be used with different solutions that, from an aesthetic point of view, adapt well to the different finishes that are normally found in bathrooms.

DIAGRAM 1: water supply distribution for a bathroom with a toilet, bidet, washbasin, and shower. 2x2 manifold plus a tee to divert water to the toilet.

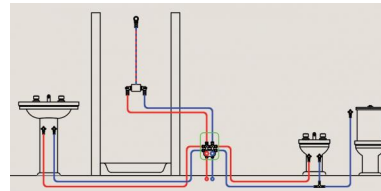

DIAGRAM 2: water supply distribution for a bathroom and a kitchen: toilet, bidet, washbasin, shower, sink, dishwasher and washing machine. 4x4 manifold

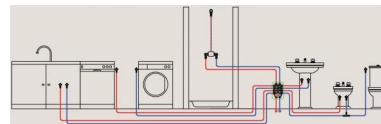
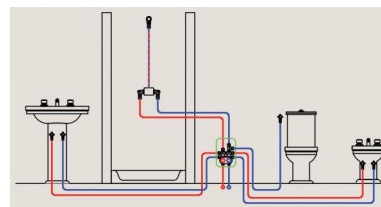

DIAGRAM 3: water supply distribution to a bathroom with a toilet, bidet, washbasin, and shower. 2x2 manifold with tee installed in the inspection box



## MANIFOLD INSPECTION AND VALVE OPERATION

No matter the version, the WELCODUAL manifold is always inserted in a single type of case. However, there are different options for inspection and the system that is used to operate the valves:

1) System without manifold inspection: there is no visible inspection door on the wall; instead, only the parts that could deteriorate over time (valve balls) can be inspected and replaced.

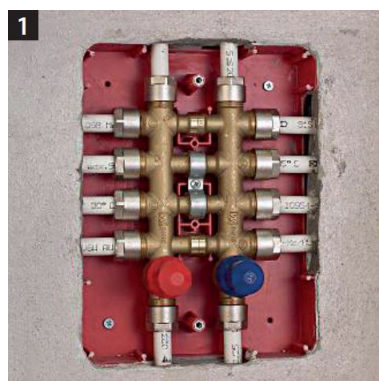

Example: 4x4 manifold installed and finished with activation of the valves by means of caps. Only the valves can be inspected and activation is always possible.



2) System with manifold inspection: a door (fixed with two screws to the case) offers full inspection of the manifold and valves. The valves, protruding outwards, are activated directly by means of two holes in the door.

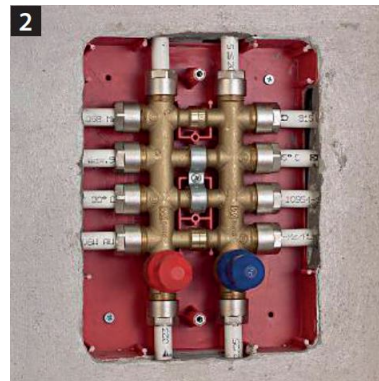

Example: 4x4 manifold installed and finished. It is possible to inspect the manifold and operate the valves after simply removing the door.



3) System with inspection of the manifold and valves: this is the most traditional system, always used in manifold systems; the two valves, incorporated in the manifold, can be operated only after opening the door.

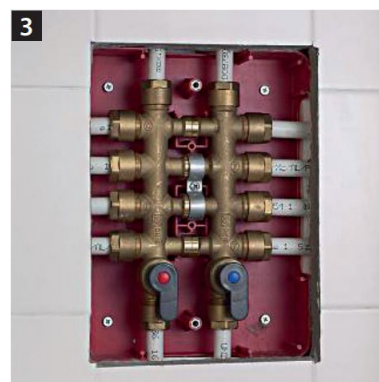

Example: 4x4 manifold installed and finished. It is possible to inspect the manifold and operate the valves after simply removing the door.



Standardised Eurocone connection

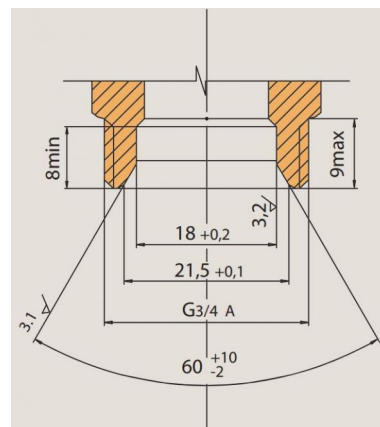

The system that guarantees the seal between the hot and cold water manifold is based on the use of 70 SH EPDM peroxide-cured O-rings. The brass alloy used (UNI-EN 12165 CW 617N) is, according to International Standards, suitable for the transport of drinking water. As with all the ball valves, the rotation of the valve rod, is 90° (a quarter of a turn) to open and close it.

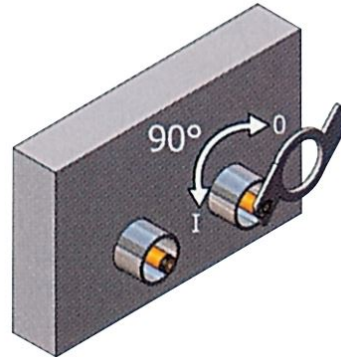

There are two valve shut-off options:

1) version with two caps and an operating key: to intervene, it is necessary to disassemble the caps and then, with the knurled key inserted under the double plate, activate the valve;

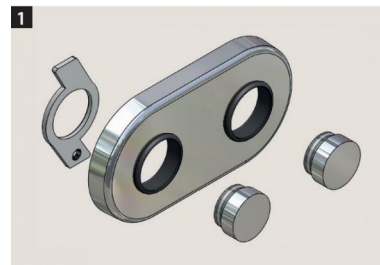

2) version with two chrome knobs that make intervention immediate since it is possible to directly operate the chrome knob, either red (hot water) or blue (cold water).

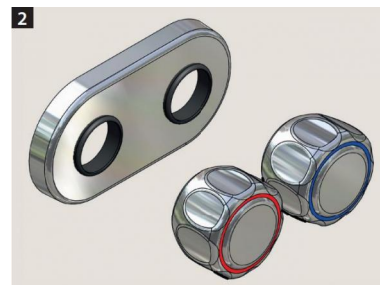

## INSTALLATION

Generally, a manifold is provided for each bathroom or bathroom-kitchen or other sanitary facility, and it is installed in different phases that the following illustrations try to clarify. Usually the manifold is fed from below, so the hot and cold water come from the floor and enter a manifold placed within the wall.

Once the installation position has been identified, the chases for the housing of the case and to allow the passage of the pipes must be provided. The recessed case is easily set into the wall using two special galvanised steel brackets; the manifold is fixed to the case using a support and a screw fastener.

As in most cases (including in the illustrated example that follows), the hot and cold water that flows into the WELCODUAL manifold is supplied from below, upstream of the stopcocks.

On the same wall as the manifold, the head couplings connect a washbasin. Branching off from the side couplings, instead, are the connections for the sanitary fixtures placed on the opposite wall (the shower, bidet and, with the addition of a tee, the toilet).

Compression fittings are used in the example.

Fixing clamps to the case.

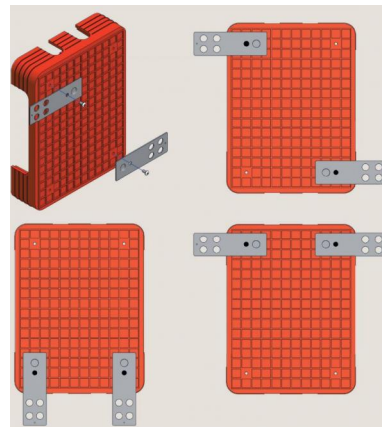



Inserting the manifold into the case.

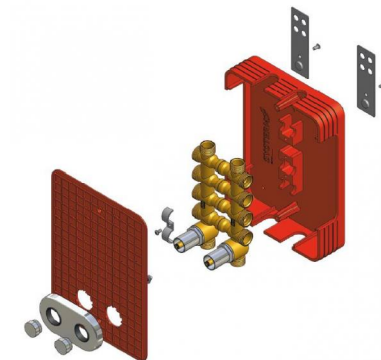

Once the chases have been made on the boarding, the case is walled after attaching the two galvanised steel brackets, positioned on the sides at the top of the case. The manifold is then fixed to the case using a clip and screw (included in the package).



The connection of the pipe to the manifold begins, paying attention to the calibration of the end. The elements of the seal are inserted into the pipe: nut, olive and insert.

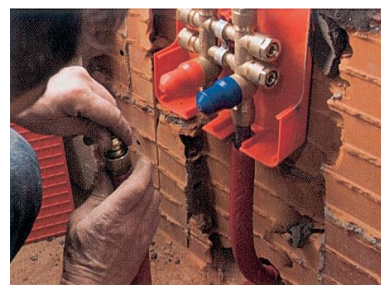

Continue to connect the offtakes to the collector; due to the proximity of the connections (37 mm between centres) on the manifold, it is essential to use a box wrench.



The cover is then attached with the two screws (included in the package); the manifold with the two built-in valves remains protected. It is advisable that it remains like this until the hydraulic test.



The chases are then grouted; at this point, a considerable part of the installation has been completed. The substrate necessary for laying the tiles will then be created.



## GASKETS REPLACEMENT

The gaskets are replaced after removing the screw complete with ball with a special tool (socket wrench).

## DIMENSIONS

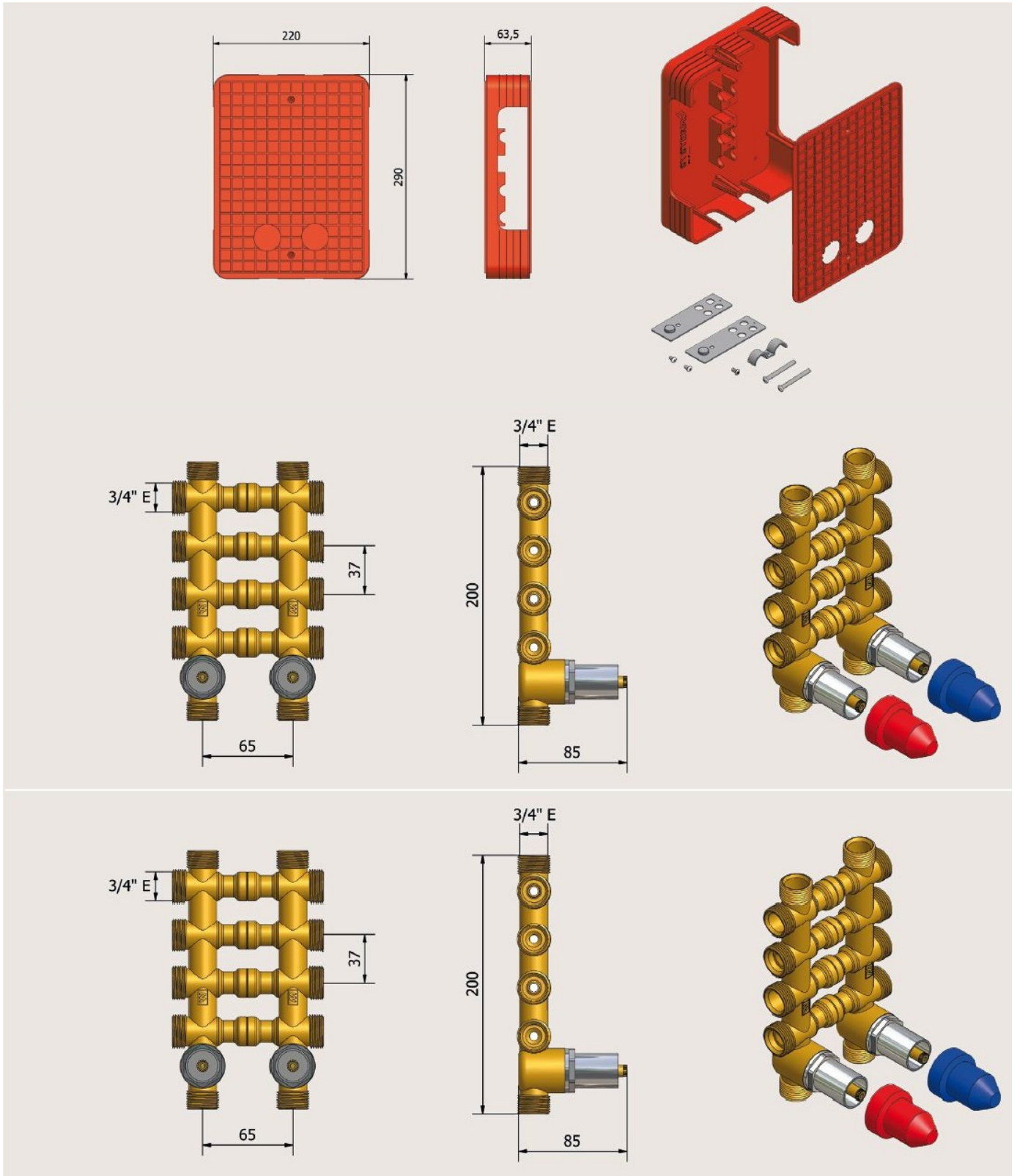



GENERAL FITTINGS SPA

Via Golgi 73/75, 25064 Gussago (BS) - ITALY

te. +39 030 3739017

[www.generalfittings.it](http://www.generalfittings.it)