

VARMO catalog

Radiant systems and
air treatment

2022

Network
Chorus[™]



General Fittings Spa
Via Golgi, 73/75
25064 Cussago (BS) ITALY
T +39 030 3739017
F +39 030 3739021
info@generalfittings.it

www.generalfittings.it





WEBSITE Plenty of news to discover. A space to find out who we are and our values. It is the most convenient and immediate gateway to discover our products and updates and download all related documents.

WWW.GENERALFITTINGS.IT



WEBSITE

GENERAL FITTINGS GOES SOCIAL!

Every week, on our social media channels you can find news, updates and insights about our company and our products. It is a quick and easy way to join our community. Come and follow us.

Scan the QR codes and follow us!



YOUTUBE

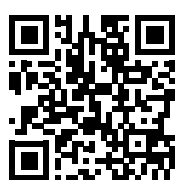

FACEBOOK



INSTAGRAM



LINKEDIN

INDEX

INTRODUCTION

ABOUT US	Pag. 6
VARMO: ADVANTAGES	Pag. 16
VARMO: SERVICE	Pag. 21
VARMO: LAYING	Pag. 23

RADIANT SYSTEMS

CONVENTIONAL UNDERFLOOR RADIANT PANELS

VARMO FORM	Pag. 43
VARMO FORM GRAFITE	Pag. 49
VARMO WELD	Pag. 55
VARMO FLAT	Pag. 61
VARMO ROLL	Pag. 67

DRY UNDERFLOOR RADIANT PANELS

VARMO TECK 23-28	Pag. 73
VARMO TECK-0	Pag. 81
VARMO ALU	Pag. 87
VARMO DRY	Pag. 93

PIPES AND ACCESSORIES FOR RADIANT PANELS

PIPES	Pag. 103
ACCESSORIES	Pag. 105

INDEX

MIXING AND WATER DISTRIBUTION

MIXING AND DISTRIBUTION UNIT

TRITONE MIXING UNIT	Pag. 113
FIXED POINT MIXING STATION	Pag. 131

MANIFOLDS

LINE 6500 MANIFOLDS	Pag. 143
---------------------	----------

AIR TREATMENT

VARMO CLIMA: DEHUMIDIFIERS	Pag. 163
----------------------------	----------

SALES CONDITIONS

SALES CONDITIONS	Pag. 171
------------------	----------

YOUNIQUE • ITALIAN



THE FUTURE STARTS WITH US

We have been designing and manufacturing efficient solutions for the plumbing and heating market since 1981. We are the perfect partner to supply systems (fittings, manifolds, mixing units, radiant panels) for multilayer, PE-X, copper, PE, stainless steel and iron pipes. Thanks to a highly professional and cohesive team, we face the challenges of the market by putting quality and our partners' needs first. Our products are 100% made in Italy and our philosophy is based on the full control of the entire production chain, as well as the constant evolution of our proposals. Our driving force is passion, encouraging us first and foremost to focus on the value of people, as human resources are our most important capital.

WE INVEST IN TECHNOLOGY AND PRODUCTION PROCESSES TO CREATE WELL-BEING FOR PEOPLE



GROW, EVOLVE AND CULTIVATE THE FUTURE

General Fittings has been manufacturing fittings, valves and manifolds for plumbing and heating systems since 1981. We cultivate art as a form of communication to represent our dynamism and our Italian character. A collaboration project was therefore launched with the Venetian artist PEETA, aimed at

enhancing our company's values. "This is for us an opportunity to combine art and business in a dialogue aimed to spread culture and develop new relationships, make us learn to think out of the box and look at things through different eyes".
Luca Gambari, CEO of General Fittings

PRESENCE IN OVER 80 COUNTRIES WORLDWIDE

+15,000 TON. OF BRASS TRANSFORMED

+200 MILLION PIECES PROCESSED ANNUALLY

155 EMPLOYEES

20,000MQ

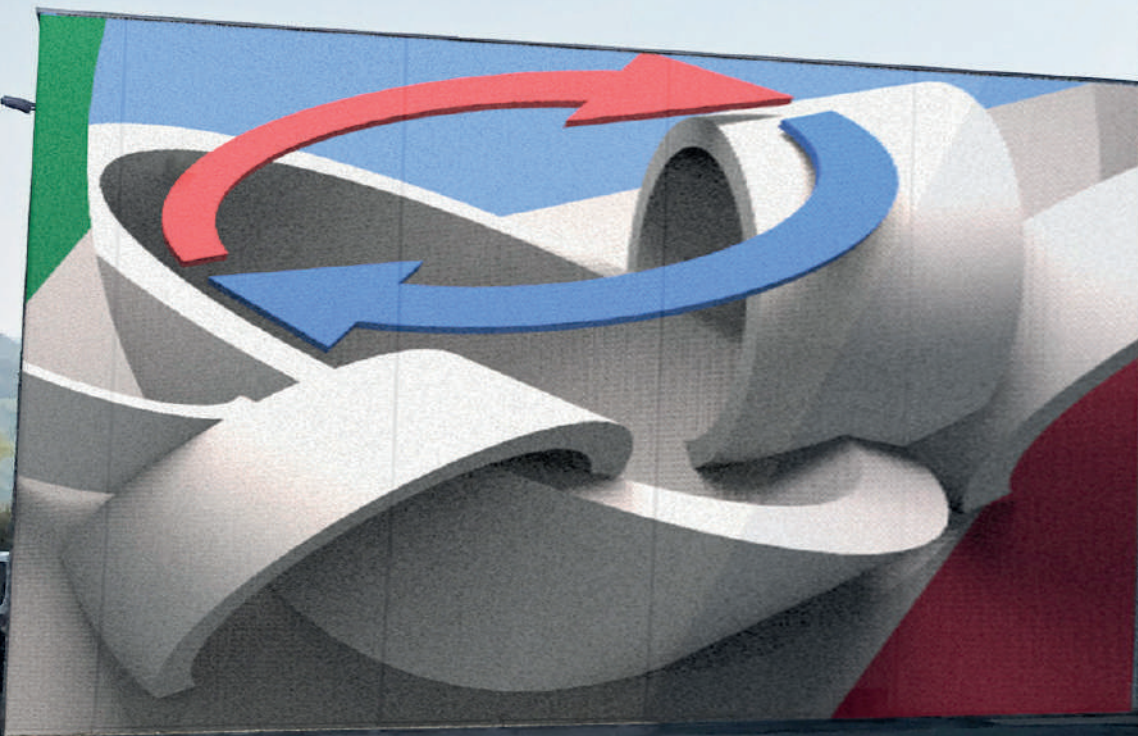

QUALITY: OUR PASSION AND PRIDE

In these 40 years, General Fittings has developed advanced manufacturing processes, all stages of which are controlled in a very careful and accurate way.



100% Made in Italy

Our products are entirely Made in Italy. All raw materials are of certified origin and exclusively processed at our production facility in Cussago (Brescia), as this is essential for ensuring our partners top quality. Our strong commitment has allowed us to achieve the exclusive "Made in Italy" certificate issued by Kiwa, a leading certification body at the global level, and to have it renewed over the years.



INTERNATIONAL CERTIFICATES

Our products are acknowledged and certified by numerous certification bodies, both national and international, and are suitable for export all over the world.



NETWORK CHORUS

CHORUS is a network of companies with proven expertise in different fields which offers a comprehensive and professional range of products and makes everything easier to manage.

GENERAL FITTINGS, KARIBA®, SEPPELFRICKE SD®:

Their products and systems are a true expression of the Italian style. Each of these brands and companies has its own identity, history and expertise, and they all share the same passion for quality and commitment to client service excellence. These companies have formed the CHORUS network, a single point of contact that will make everything easier for you thanks to unique solutions and advantageous offers, as well as a highly organized and integrated technical support service.

A UNIQUE PARTNER FOR MORE OPPORTUNITIES

Network
Chorus™



www.generalfittings.it



www.kariba.it



www.seppelfricke.it



FITTINGS FOR COPPER AND STEEL PIPES

FITTINGS FOR IRON PIPES

FITTINGS FOR POLYETHYLENE PIPES

FITTINGS FOR PE-X PIPES

FITTINGS FOR MULTILAYER PIPES

MANIFOLDS

BALL VALVES

RADIATOR VALVES



COLLECTION

PLUMBING PRODUCTS

Our 40 years of expertise in the plumbing and heating industry allows us to offer a wide range of high quality products. Our team spirit and will to respond to our partners' needs and requirements are the driving forces of our research and development activity, as well as of the continuous evolution of our product range.

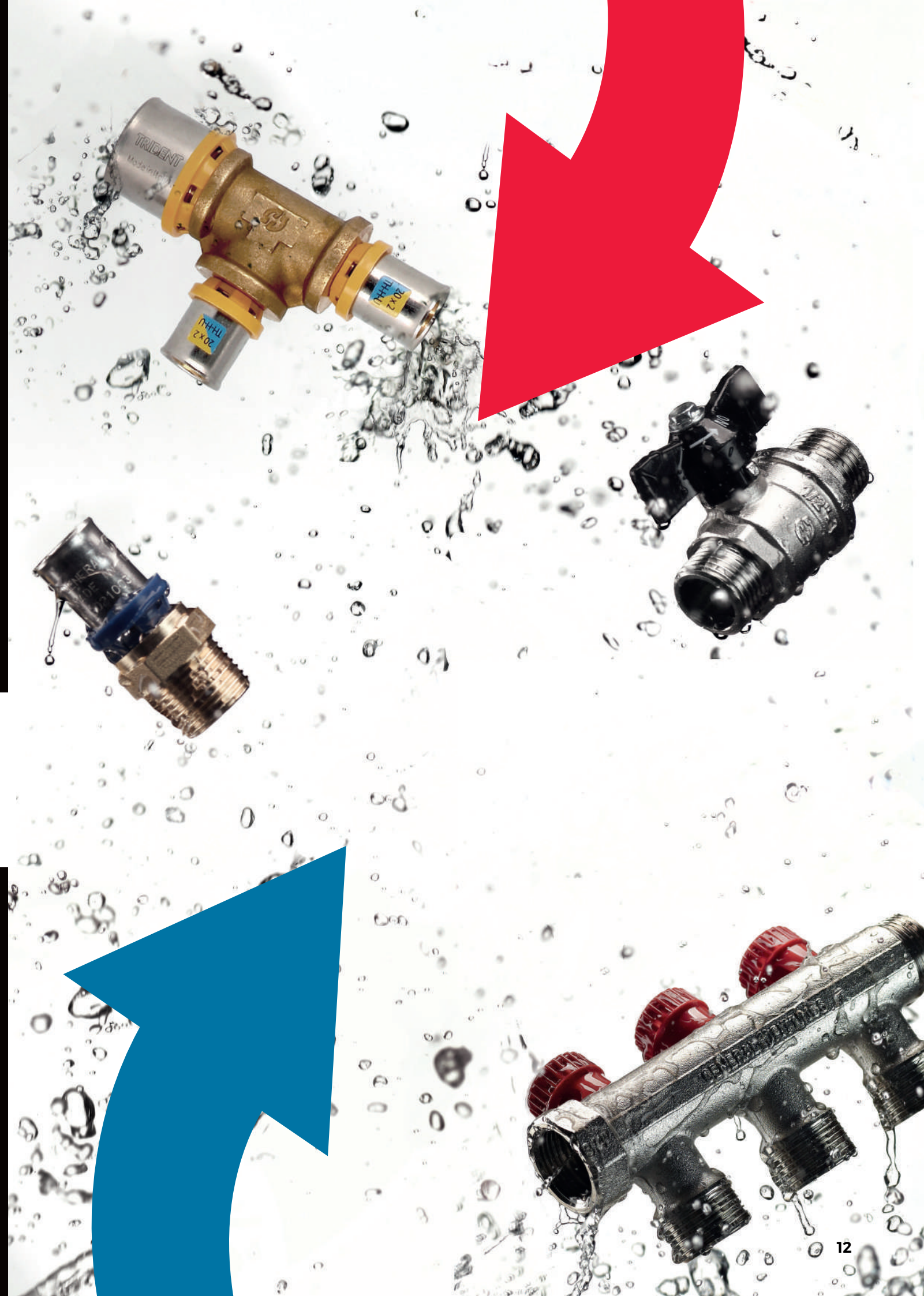

“The home should be the
treasure chest of living”
Le Corbusier.





WHY CHOOSE VARMO UNDERFLOOR HEATING

1. Increased comfort and temperature's uniformity
2. Increased energy-efficiency
3. More control = costs less to run
4. Works with all floor types
5. Freedom of design
6. Limited maintenance
7. Easy to install
8. Healthy living
9. Can be integrated with boilers
10. Combines with VMC systems ensuring high indoor air quality
11. Silence

COMFORT AND WELL-BEING

Heat from underfloor heating systems is much more comfortable and evenly spread compared to that of a traditional radiator. The air is fresher and more oxygen rich. The result of this is that you can experience a more evenly distributed and comfortable level of heat, particularly as you can easily control it with a thermostat. With radiators you can sometimes experience an uncomfortable level of heat, with the air becoming dry.

Underfloor heating actually helps to conserve the moisture in the air, preserving a more comfortable atmosphere. The absence of radiators and convectors in the system reduces the movement of air and dust that can cause allergies. Convection heating currents can serve to aggravate asthma and dust allergies due to the fact that the currents circulate and distribute a greater level of dust throughout the room and household. Underfloor heating provides a cleaner radiant heat causing less discomfort to sufferers.



FREEDOM AND FLEXIBILITY

The choice of underfloor heating does not constrain the type of floor you choose to lay. This type of heating is suitable for all types of floor coverings: parquet, gres, laminate and marble. Carpet is obviously not recommended because, due to its composition, it prevents the radiation of heat.

From an application point of view, it is the radiant system that adapts to the type of floor chosen and not vice versa, offering the user the guarantee of being able to choose how to decorate their spaces with maximum freedom.

In general, it is advisable to choose the type of floor beforehand, in order to install the most suitable heating system and the most suitable type of screed. This constraint can also be easily avoided through innovative solutions of distribution of the heating fluid (such as TRITONE mixing unit).

Underfloor heating systems are suitable for installing in a wide variety of renovation projects from wet room conversions to conservatory extensions. Most systems can be retrofitted with your existing sub-floors without the need of excavation, allowing a fast and efficient installation. One of the most important features to look for in a floor heater when retrofitting is the system depth.

When refurbishing, it is important to minimise floor build-up heights as the ceiling height is fixed (unlike a new-build project where you can adjust this during the design stage). VARMO offer a selection of low-profile floor heating solutions that will have little-to-no effect on the floor build-up.

Underfloor heating thus adapts to different types of buildings: it can be used in residential buildings as well as in apartment buildings, offices up to sports facilities, buildings for workshop, buildings of historical-artistic value and production sites. According to research by the Q-RAD consortium (Consorzio Italiano Produttori Sistemi Radianti di Qualità), eliminating traditional radiators in favour of a radiant floor can save 10% more space.



ENERGY EFFICIENCY AND ECONOMIC SAVINGS

The convenience of underfloor heating lies in its ability to meet your heating needs in an efficient and cost-effective manner; also offering a more comfortable home environment for everyone. The first important point to make is that underfloor heating system requires a lower input temperature than a radiator to work effectively.

Due to their small surface area, radiators typically need 70°C-80°C to heat a building. Because the floor area of a room is much greater, the underfloor heating requires a lower input temperature, between 30-40°C. This lower input temperature is where the energy-saving potential lies. Underfloor heating systems are estimated to use 15-40% less energy than a radiator.

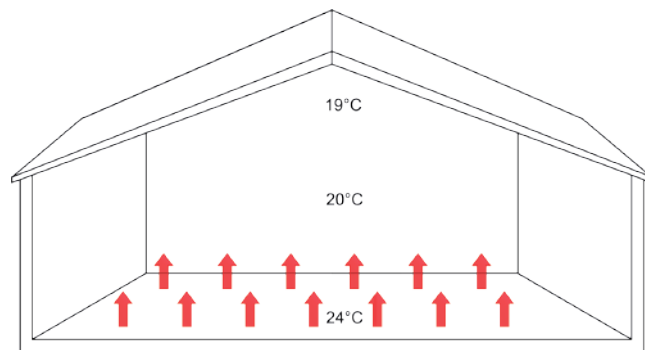

UFH produces radiant heat, whereas radiators rely on convection to spread heat around the room. The air warmed by a radiator moves upwards and once it has cooled, it moves downwards to be reheated by the radiator. Ultimately, this establishes a flow of warm and cool air throughout the space, whereas UFH delivers an even spread of heat, resulting in impressive internal comfort levels. The even spread of heat also means that you can rule out having hot spots and chilly corners within the same room, instead maintaining the same level of comfort throughout.

PLANT DIMENSIONING AND TRANSMITTANCE COEFFICIENT

Underfloor plant system must meet the requirements of UNI EN 1264. This regulation brings together all warnings for the design, sizing and installation of the system in order to guarantee the standards of comfort and well-being that underfloor heating can give. According to UNI EN 1264, the sizing of the system depends on:

- the indoor and outdoor temperature
- the underlying temperature
- the thermal resistance of the coating (transmittance coefficient)

Thermal transmittance
In thermal engineering, thermal transmittance is a physical quantity, measured in $W/(m^2K)$, that indicates the amount of heat power exchanged by a material (the floor covering) with respect to a unit area. It defines the tendency of an element to exchange energy, that is to say the opposite of the insulating capacity of a body. The sizing of the system and the precise calculation of the coefficient must be extremely accurate to achieve the desired heat results and improve system efficiency.





VARMO SERVICE

General Fittings has a dedicated team to support and help the customer to define the project and the type of installation.

Qualified and trained operators are always available to answer within a few fromys to the various requests for information and clarification on the system.

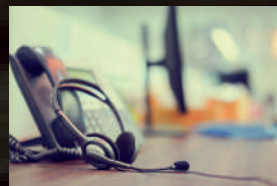

Direct line:
TEL +39 030 3739017
MAIL varmo@generalfittings.it

THE RIGHT SOLUTION FOR EVERY SPACE

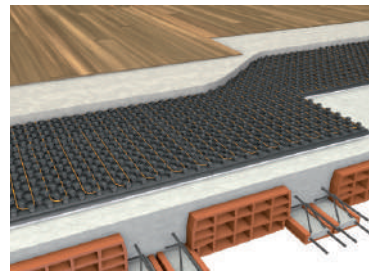

VARMO FORM

Wet solution - cement screed (40mm above the pipe) - dry according to UNI EN 1264

Insulation thickness + boss: from 32 to 82 mm
Panel dimension: 1400x800mm
Pipe Ø16-17

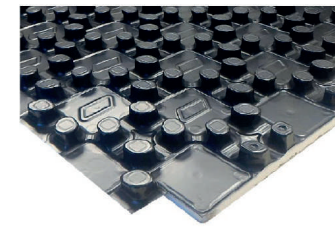

VARMO TECK 23-28

Wet solution - Self-leveling screed (10mm above the pipe) - dry according to UNI EN 1264

Insulation thickness + boss: 23 and 28 mm
Panel dimension: 1450x850mm
Pipe Ø16-17

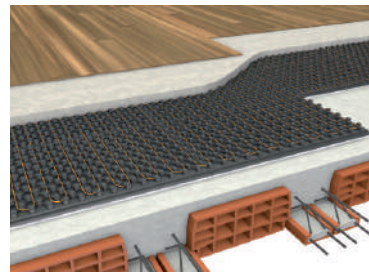

VARMO FORM GRAFITE

Wet solution - cement screed (40mm above the pipe) - dry according to UNI EN 1264

Insulation thickness + boss: from 32 to 82 mm
Panel dimension: 1400x800mm
Pipe Ø16-17

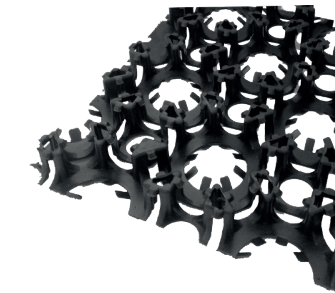

VARMO TECK-0

Wet solution - Self-leveling screed (3mm above the pipe) - dry according to UNI EN 1264 - net in PP-R

Boss height: 18.5 mm
Panel dimension: 841x641mm
Pipe Ø14-18

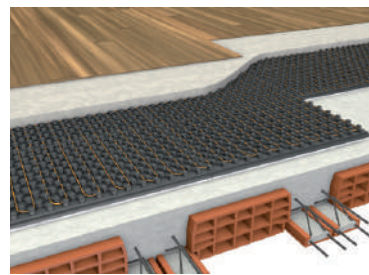

VARMO WELD

Wet solution - cement screed (40mm above the pipe) - dry according to UNI EN 1264

Insulation thickness + boss: from 40 to 55 mm
Panel dimension: 1400x800mm
Pipe Ø16-17

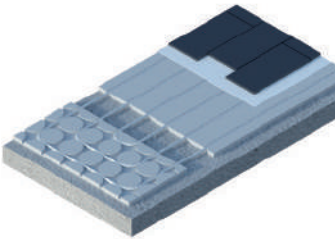

VARMO DRY

Dry solution (3mm above the pipe) - Panel in cement fiber

Height: 18 mm
Panel dimension: 600x298 mm; 1200x600 mm
Pipe Ø11.6-12

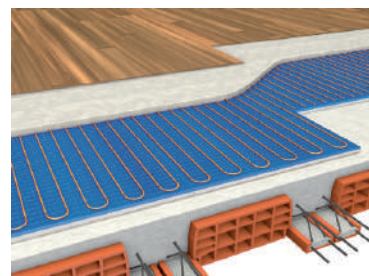

VARMO FLAT

Wet solution - cement screed (40mm above the pipe) - dry according to UNI EN 1264

Insulation thickness + boss: from 20 to 40 mm
Panel dimension: 1400x800mm
Pipe Øall

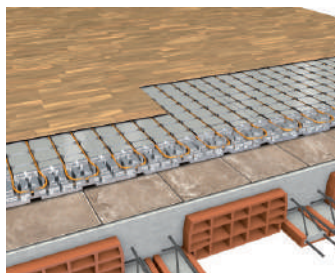

VARMO ALU

Dry solution (3mm above the pipe) - Expanded polystyrene panel covered with a removable aluminum sheet. A steel plate must be placed above

Insulation thickness: 28 mm
Panel dimension: 1200x600 mm
Head: 600x300 mm
Steel plate: 1 mm
Pipe Ø16-17

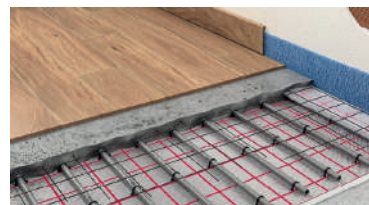

VARMO ROLL

Wet solution - cement screed (40mm above the pipe) - dry according to UNI EN 1264

Insulation thickness: from 20 to 40 mm
Dimension: 1000x10000 mm
Pipe Ø all



INSTALLATION GUIDELINES

Underfloor heating (UFH) systems are not difficult to design or to install, but it is important that the guidelines and instructions are carefully followed to ensure that the system performs correctly once installed and has a long service life. This guide explains the fundamental principles and design of VARMO UFH and also gives installation guidelines for the components and systems.

Heating engineers familiar with installing conventional central heating systems will be accustomed to working with radiators or convectors.

Installing UFH is different, although the heat source is often the same, the materials and method of heat distribution are different.

1. There is a central distribution point, the manifold, which is served by the primary heating source and which distributes warm water to the pipes of the UFH system.
 2. UFH operates with a low water temperature flow and return and therefore requires its own water temperature controls and own pump.
 3. UFH uses the whole floor area as the heating medium, replacing radiators or convectors.
- The use of Varmo pipe systems makes the installers physical task much easier. However, it is vital that the work is done correctly, as once the installation is complete and pipes are embedded in the floor, it would be difficult to make changes. The radiant system must be installed strictly in accordance with the project drawings.

This guide is not intended to override the skills of the individual installer; it is published simply as a guide to installing Varmo Underfloor Heating Systems. It is hoped that it will provide a useful background on installation for those who are not yet familiar with the system.

Principles

The principle of UFH is very simple. Rather than mount metal panels on walls, pipes are laid in the floor and warm water circulated

so that the floor effectively becomes a large radiator. Because the floor is so large compared to a normal wall mounted radiator, it needs to run only a few degrees above the air temperature to provide enough warmth to gently heat the whole room. The primary aim of the floor heating design is to create an even, uniform surface temperature across the entire floor area within the building in order to ensure a consistent comfort level throughout the structure. When the floor temperature is higher than the air temperature, the floor will emit mainly radiant heat. The heat output from the floor is directly related to the temperature of the floor and that of the surrounding air. Loops of pipes are normally installed beneath the whole floor area. These loops are connected to a central manifold, which is supplied with hot water from a suitable heat source - such as a boiler or heat pump - heat pumps are becoming ever more popular due to the potential energy savings. Usually, with boilers as the heat source, the central heating water is mixed before it reaches the manifold to reduce the water temperature to that suitable for the UFH system. Controls reduce the water temperature to maintain the correct design temperature and pump the warm water through the UFH pipes

Heating with UFH

UFH is a true radiant system and heats from floor to ceiling. UFH avoids wasted heat at high level and since the whole floor is heated evenly, optimum comfort is achieved everywhere in the room. In fact, the room thermostat can be set 1 - 2°C lower than a radiator system and the room will still feel more comfortable! Running the system at a lower temperature and reducing the heat wasted at levels above head height makes for significant savings on fuel costs. The exact savings that can be expected are difficult to determine, as there are operational factors that also need to be considered.



Heat Outputs

It is the clients responsibility to check that heat losses of the building, carried out by a heating consultant or engineer, are compatible with the outputs given. Generally, the maximum output from an UFH system is often stated at between 70 and 100 W/m². The actual output achieved is a direct relationship between the difference in floor surface and room air temperatures. The floor construction, floor covering material, pipe size, pipe spacing, and the temperature of water circulating through the UFH pipes are major factors that determine the floor surface temperature. When designing conventional heating systems it is necessary to know the required heat output to be able to size the heat emitter. However, for UFH the size of the emitter is fixed - it is the floor area. Hence, the heat output is a function of the operating temperature of the floor, the floor area, and room air temperature.

Floor Construction Type

Floor construction is another key factor in the design. Screed floors, suspended wooden floors and floating floors all require individual consideration to ensure optimum performance and an even distribution of heat across the surface of the floor. The screed or solid floor system relies on the conductivity of the screed or concrete to conduct the heat from the pipe surface to the underside of the floor finish. Because the screed is itself heated to conduct the heat it tends to store considerable amounts of heat and thus provides a slow response when both heating up and cooling down. Timber floor systems rely on the conductivity of components fitted within the floor to conduct the heat from the pipe to the underside of the floor finish. In order to achieve good results the pipes must transfer their heat evenly to the floor surface. Inadequate heat dissipation and hot spots can cause unsightly shrinkage, particularly with

natural wood boards. Because the mass of a timber floor structure is less than the mass of a screed floor, the system response of a timber floor system is usually much faster.

Pipe Spacing

In order to calculate the amount of pipe required, the following guide can be used:

LINEAR METRES OF PIPE PER M2 ACCORDING TO PITCH

PITCH	5	10	15	20	25	30
PIPE Ø11,6 / 12	-	10,0	-	-	-	-
MAXIMUM RING 60 M. REFERENCE SYSTEM: VARMO DRY						
PIPE Ø16 / 17	-	10,0	6,6	5,0	4,0	-
MAXIMUM RING 100 M. REFERENCE SYSTEMS: VARMO FORM, VARMO WELD, VARMO FLAT, VARMO ROLL						
PIPE Ø20	-	10,0	6,6	5,0	4,0	3,3
MAXIMUM RING 150 M. REFERENCE SYSTEM: VARMO ROLL						

Important Note: When calculating your pipe requirement, remember to add the feed/tail pipe lengths, between manifold and room, to your calculations.

Before Installing

Prior to installation, it is important that the installer makes sure that sub-floors are clean, level and are correct for the depth of construction needed to incorporate the underfloor heating.

Avoid notching the insulation to accommodate the pipes; this would form harmful thermo-acoustic bridges.

If many pipelines run through the floor slab, it is necessary, compatibly with the finished floor level, to embed them in the concrete in order to level the floor slab.

If the work is carried out during the winter season, it would be better to have the exterior windows and doors already installed, or at least there should be protections in place to avoid inconveniences from bad weather conditions.

Waterproofing (if any)

For floors on the ground, where there is a possibility of moisture infiltration from outside, we recommend the laying of a waterproofing sheet of polyethylene (PE) with a thickness of 0.2 mm, suitably overlapped (at least 10 cm), which must be laid on the walls up to a height of 15 cm.

Screed reinforcement (if any)

The use of reinforcement of the screed must follow the rules of art and prescriptions of the Works Manager or Designer. In no case may the reinforcement, or net, have a function of "anti-shrinkage" of the screed. It consists of electro welded net (mesh 150 x 150 x Ø 4 mm) and must be placed in the middle part of the screed.

The net must be sufficiently overlapped. The reinforcement is intended to contain the size of possible cracks, it cannot however avoid them altogether.

The reinforcement must be interrupted at the thermal insulation expansion joints (if any): consistent with the final thickness of the floor, floors on the ground, cellars or porches (unheated) must be additionally insulated in order to limit heat loss to the outside.

Perimeter edging

Fix, using nails or glue, the perimeter edging around the entire perimeter of the room, on the columns and on each vertical element. The polyethylene sheet of the strip is laid over the insulating plate.

Accuracy in execution is very important so that no thermal-acoustic bridges are created and the thermal expansion of the slab is avoided.

Expansion joints

The joints already present in the supporting structure must be respected up to the final paving by filling with elastic materials.

It should be borne in mind that, due to the temperature, it expands by approximately 0.01 mm/ml for every degree of temperature increase: for this reason, screed surfaces

exceeding 40 m² must be divided with expansion joints and the length of the individual surface area must not exceed 8 / 10 ml (e.g. along corridors).

Heating system pipes intersecting expansion joints must be suitably sheathed to allow free mutual expansion between joint and pipe. Expansion joints must be provided at each door threshold.

Insulating plate

Starting on the opposite side of the door, adhering to the peripheral strip, lay the insulating plates using the specially designed interlocking.

The plates should be laid with the joints staggered to make the assembly more stable. Unheated areas must also be covered by the plates.

Pipe laying

This is done by attaching one end to the starting manifold by means of the appropriate fitting, after inserting the corresponding bend. The first circuits should be the ones furthest from the manifold, trying to avoid overlapping.

The fixing of the pipe to the panels is ensured by the special plate profile: to keep the pipe in place where it tends to rise, use the pipe fixings supplied with the insulating plates.

If the thickening of the pipes near the manifold is excessive compared to the design drawings, it is necessary to insulate some of them with corrugated sheathing in order to restore the design pitch.

The laying plans indicate the lengths of the individual loops, to give the possibility of comparing the laid meters with the length values given on the pipe, to optimize the roll, dividing it between the various loops with the minimum deviation.

Circuit marking

Immediately after laying, before pouring the slab, the two ends of the circuit should be marked with a label in order to avoid mistakes (i.e. circuit no. 7-supply).

Inside each cabinet there must be a diagram of the manifold showing the various circuits.

Cabinets and Manifolds

The cabinets and manifolds must be installed in a central position in relation to the areas to be served.

The maximum distance between the collector and the ring must not exceed 15 m.

They must be installed at a higher level than the pipe-laying level.

Floating screed

Before the execution of the screed, it is necessary to check the integrity of the perimeter edging to ensure good thermal-acoustic insulation. The polyethylene foil of the band must be laid on top of the insulating plate. The circuits are kept under pressure (2 / 3 bar approx.) until the concrete is fully cured in order to reveal any cracks during the casting phase. The concrete, with a minimum dosage of 300 kg/m³ (300 kg of cement per m³ of aggregate), mixed with the fluidifying admixture, will be laid without any special technical precautions.

The minimum thickness is 45 mm, measured above the pipe. Do not turn on the heating to accelerate the curing process of the concrete.

Plant load

The loading of the system must be carried out slowly in order to minimize air bleeding. To avoid inconveniences due to low temperatures, the appropriate amount of antifreeze should be injected into the system.

Hydraulic testing

With all circuits open, pressurize the network to 4 / 6 bar for at least 24 hours. It is advisable to check and tighten the fittings further and leave them under pressure. Ensure that there are no leaks by observing the value indicated by the control manometer.

INSTALLATION INSTRUCTIONS: traditional panels

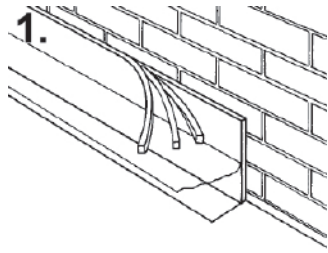

1. Fix the perimeter strip around the entire perimeter of the room, on the columns and on each vertical element, above the plaster.

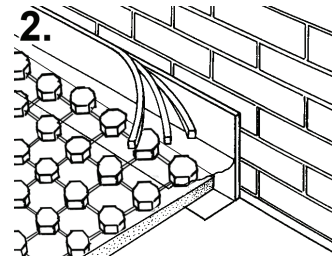

2. Lay the insulating plates adhering to the perimeter strip.

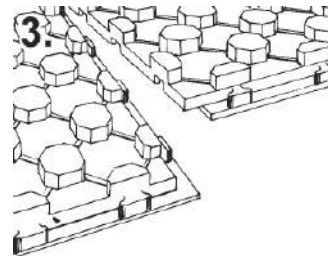

3. The joints must be staggered to make the whole more stable.

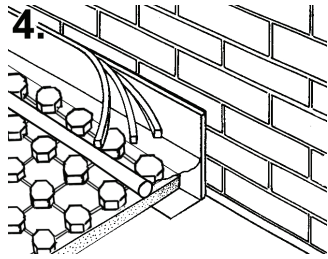

4. Lay the polyethylene sheet of the band over the insulating plate and lay the polyethylene pipe on top of it in order to avoid possible infiltration of the screed.

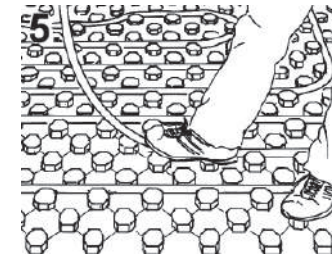

5. **CIRCUIT REALIZATION**
Once the panels have been fixed to the floor, you can proceed with the installation of the pipe by inserting it into the grooves on the panels.
When laying the pipe, start from the delivery manifold following a double spiral pattern, unless otherwise specified in the project.

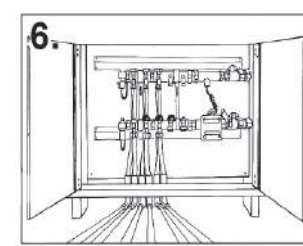

6. At the point of exit from the floor, the pipes must be protected with the fixing bends.

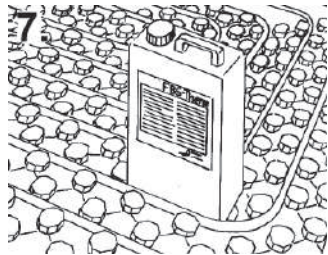

7. The additive in the amount of 150-200 gr / m² must be added to the laying casting.

INSTALLATION INSTRUCTIONS: dry panels



1. Fix the perimeter strip around the entire perimeter of the room, on the columns and on each vertical element, above the plaster.



2. Lay the insulating plates adhering to the perimeter strip.

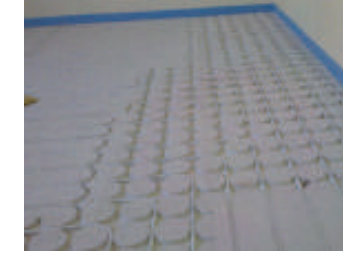

3. Lay the polyethylene sheet of the band over the insulating plate and lay the polyethylene pipe on top of it in order to avoid possible infiltration of the screed.



4. **CIRCUIT REALIZATION**
Once the panels have been fixed to the floor, you can proceed with the installation of the pipe by inserting it into the grooves on the panels. When laying the pipe, start from the delivery manifold following a double spiral pattern, unless otherwise specified in the project.

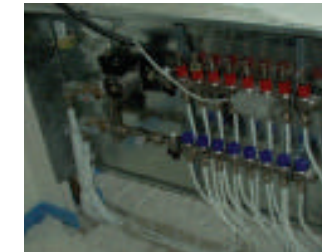

5. At the point of exit from the floor, the pipes must be protected with the fixing bends.



6. **LEVELING WITH TOPPING MORTAR**
With the topping up mortar, the traces of the panels are covered in order to create a well-leveled surface on which to fix the new flooring.

PLANT EXECUTION

PRE-CLEANING

Preventive cleaning of the system is strongly recommended to ensure its long life and consistent performance levels. Before loading the circuit, it is necessary to perform a good washing until the water is perfectly clean.

Pickling is the removal of oxides from metals and processing residues (oils, shavings, hemp residues, bad pastes, etc.). In fact, remember that new does not mean clean! We also recommend the installation of a magnetic dirt separator on the system's return circuit, before entering the boiler (or heat pump), in order to intercept impurities that could damage the exchanger and circulators.

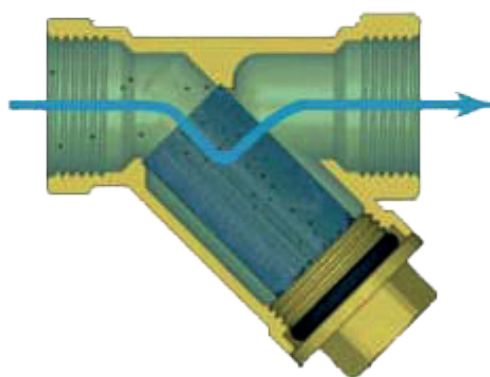

EARTHING THE INSTALLATION

It is also necessary to remember to earth the installation in order to ensure a long life for the materials. Once the dispersion system is in place, it must be ensured that all necessary connections to the protective conductor have been made.

ANTI-ALGAE ACTION

It is recommended that specific products with bactericidal / anti-algae action be added to the heat transfer fluid to prevent the formation of impurities / algae during operation of the system.



TESTING ACCORDING TO UNI EN 1264-4

Leak test

Once all the circuits have been laid, the hydraulic tightness test must be carried out as required by standard UNI EN 1264-4. Pressure manometers must be placed on the manifolds to verify that the pressure remains constant at 2 bar for the 5/6 hours of the test.

The hydraulic tightness test process must be documented.

Once the test has been carried out, the contractor can cast the screed with the system under pressure at 4/5 bar.

First plant start-up

This operation must be carried out at least 21 days after laying the backing layer of cement or in accordance with the manufacturer's instructions and in any case after at least 7 days in the case of anhydrite backing layers.

The initial heating starts at a supply temperature of between 20 and 25°C, which must be maintained for at least 3 days. Thereafter, the system must be operated for a further 3 days with water at a temperature between 20 and 25°C. The process of starting the heating must be documented.

FLOORING: LAYING ON SCREED CURED

Laying may not begin until 28 days after the screed has been laid.

Before laying the floor, the screed must be heated: however, it is not recommended to begin this operation until 21 days after casting the screed.

During the heating phase, the flow temperature must not exceed a daily increase of 5°C and must not exceed 35°C.

A few days before laying the flooring, the heating should be switched off, or during the winter season, reduced to a flow temperature of 15-18°C.

If the system was in operation during the laying of the cladding, the temperature used may not be changed for three days (in the case of elastic cladding) or for 21 days with tile or stone cladding.

Tiles and marbles: these materials are the most suitable for underfloor heating, as they are characterized by low thermal resistance. They can be glued directly onto the cured screed, or laid with a bed of csl bedding mortar, which must be admixed like the underlying 'floating screed'. In the second case, the screed must still be moistened to facilitate setting.

Parquet: before starting laying, the floor must be heated as described above, and maintained for at least 15 days. The wood must be dry; therefore, it is advisable to store and lay it for at least 8 days in the heated room so that it loses its residual moisture. The maximum thickness should not exceed 13/15 mm. The floor temperature must be maintained for a further 3 days after the end of the laying work. The laying methods are indicated by the supplier company.

PVC: before starting laying, the floor must be heated as described above. PVC sheeting, in sheets or slabs, is bonded to the screed with neoprene or similar glues; avoid using bituminous glues. If the heating was on during the laying of the flooring, the floor temperature must be kept constant for a further three days after the end of the laying work.

The laying methods are specified by the supplier company.



Carpet: before starting laying, the floor must be heated as described above. Choose a type of carpet with a known thermal resistance not exceeding 0.15 K/W and suitable for underfloor heating.

The carpet must adhere perfectly over the entire floor surface to facilitate heat transmission. The glue and laying methods are those indicated by the supplier. Avoid the use of bituminous glues.

Skirting board: trim the part of the peripheral strip that protrudes from the flooring. The expansion joint between the flooring and the skirting board must be at least 5 mm and must be sealed with elastic material.

FLOORING: WOODEN FINISHING

A topic close to the hearts of many designers and architects is the installation of a hydronic radiant system under a wooden floor.

For the installation of parquet on a system with panels with solid bosses, there are no laying restrictions. In fact, floating, glued, and nailed installation (subject to checking the characteristics of the screed) are suitable for all the systems listed.

For the installation of parquet on a system with a flat panel, again there are no regulatory constraints, but it is advisable to check the residual moisture content of the screed.

For the installation of parquet on a low thickness system that can provide different types of finish, i.e. self-levelling screed or dry finish, the installation of the wood flooring can be either floating or glued.

For glued installation, the instructions of the fluid screed manufacturer and the parquet manufacturer must be followed.

Many wooden floors are suitable for laying on a heated screed as long as the elements are small in size and above all of stable wood species (oak, bamboo), in order to limit the extent of cracks that may form over time. The presence of an impermeable airtight element is required that strongly limits the passage of water vapor and controls the phenomenon of condensation within the screed system (according to UNI 11470).



OPTICAL EFFECTS AND DEFORMATION

CURLING EFFECT

These are concave deformations that affect the screed before the tiles are laid.

The screed undergoes very rapid surface drying, which results in faster shrinkage of the upper part. As a result, the screed rises at the sides, under which voids will be created which, when subjected to loads, will break with consequent cracking and/or detachment of any tiles already laid.

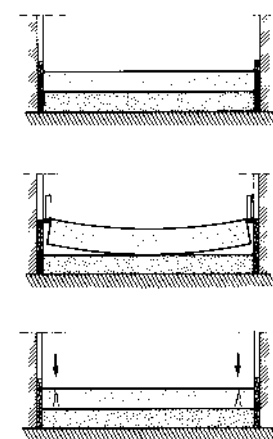

WRAPPING EFFECT

These are convex deformations that affect the screed after the tiles have been laid. The screed's tendency to shrink is hindered by the tiles, which tend to expand. The bowing creates cracks between the tiles, which, if well bonded, will not detach. When subjected to loads, the screed tends to crack in the centre. With a solidarized floor, this phenomenon is evident: the screed sinks at the sides and tends to crack in the middle, while the skirting remains spaced out and appears to rise.

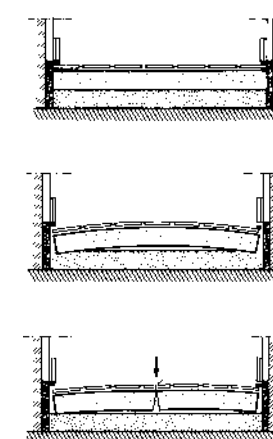

ANCHORING OF PIPES: REPAIR ACCORDING TO STANDARD

In some rare cases, it may happen that pipes embedded in the screed are damaged or punctured as a result of mechanical actions during the setting-up of furniture, for example when anchoring sofas or armchairs in environments such as theatres or hotel lobbies.

In these cases, invasive demolition is not necessary, but one can proceed with a targeted repair using techniques restoring the pipe by targeting only the leakage. First, we proceed, with the system switched on, by searching for leaks using thermography: this is a non-destructive verification technique, carried out with electronic or contact instrumentation thanks to which it is possible to highlight different types of anomalies. Secondly, proceed by draining the affected circuit from the carrier fluid, acting on the actuators at the manifold. At this point, carefully remove the screed around the affected area and proceed to repair the pipework.

In order to carry out a proper repair of the mechanically stable pipe, cut the pipe by removing the damaged section, reconnect the two sections through the use of two connection fittings and a threaded fitting, and proceed with localised reconstruction of the screed. It is essential that the body of the repair is anchored to the floor slab using a collar with a pin and dowel, like the one in the figure, to prevent the traction of the two pieces of pipe, over time, from impairing the repair by damaging the insulation panel and screed. It is essential that the body of the repair is anchored to the floor slab using a collar with a pin and dowel, like the one in the figure, to prevent the traction of the two pieces of pipe, over time, from impairing the repair by damaging the insulation panel and screed.

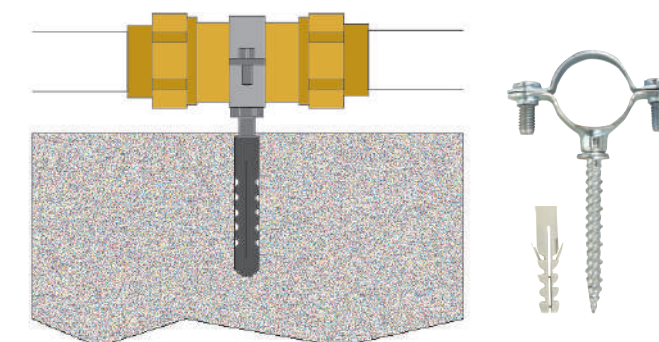

PERIMETER BAND: THE IMPORTANCE OF JOINTS

The peripheral strip is laid along the perimeter walls and on all structures (columns, etc.) that vertically delimit the rooms to be heated or cooled. It should be positioned after the plaster has been applied and trimmed only after the floor covering has been laid. It has the function of:

- thermally insulate the slab from the walls;
- acoustically isolate the floor from the rest of the structure;
- elastic joint that allows thermal expansion of the floating slab;
- especially at the thresholds of French windows, significantly reduces the transmission of heat, by conduction to the outside;
- prevent concrete penetration between the plate and the peripheral strip by means of a 2 mm polyethylene sheet to be folded over the insulating plate. (DIN 18560)

In order to understand the correct use of expansion joints, we must first understand the reasons why a floor not only moves, but also shows changes in its dimensional stability: a crucial factor is the temperature, which affects the volume of the materials subjected to thermal change.

At both surface and structural levels, materials react to thermal shock with expansion and retraction of volumes, and these physical changes must not be blocked but accommodated.

Another very important factor to take into account is movement: a floor (screed) is made with a grid system to deliberately give the body an elastic structure.

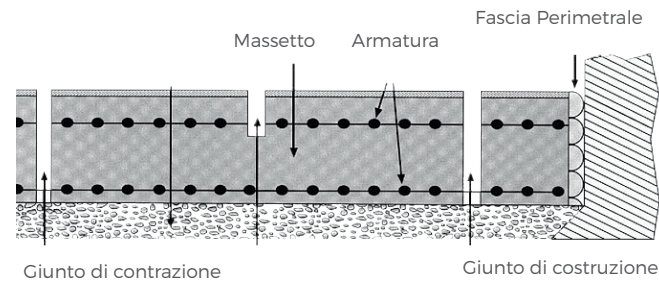
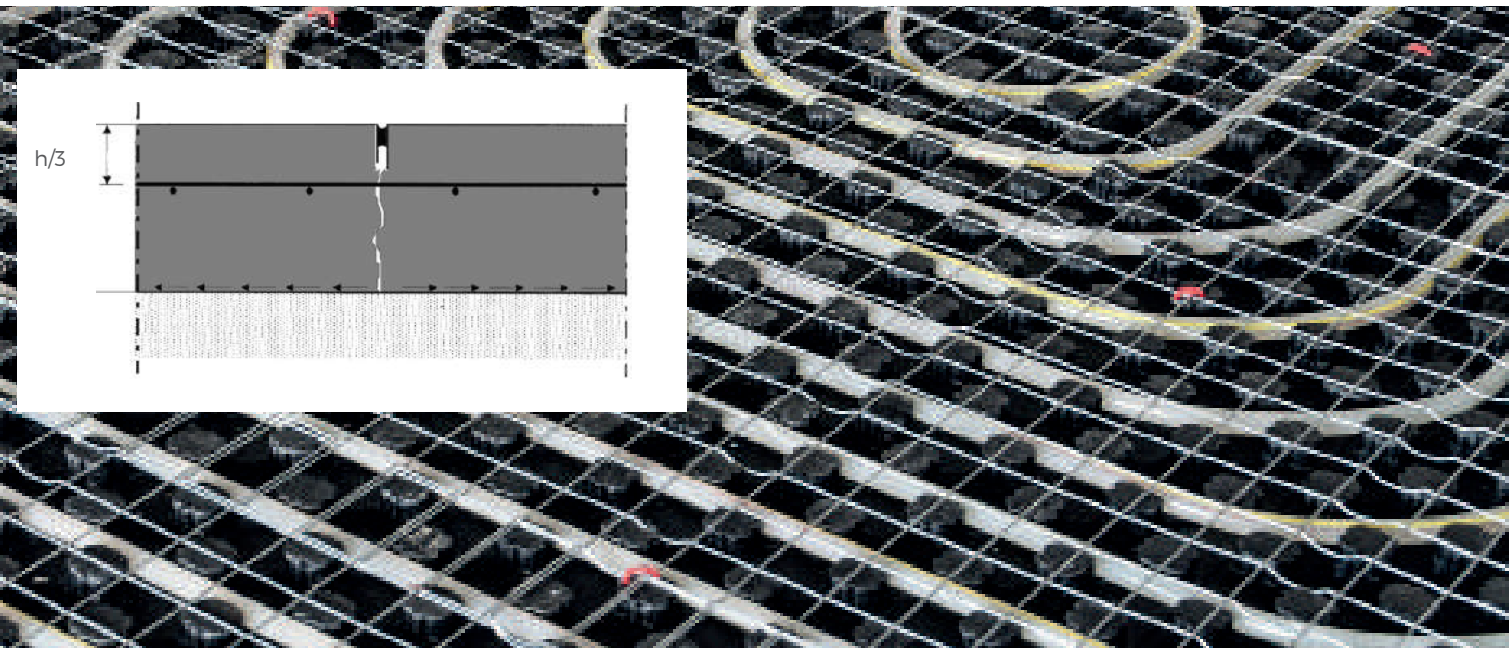

SCREED EXPANSION
 Coefficient of expansion ~ 0.012 mm/mK Example of expansion of a 20 m long screed
 $20m \cdot \Delta t 30^{\circ}C \cdot 0,012 = 7,2 \text{ mm}$

For these reasons, slabs are 'reinforced' in the casting phase with a glass or plastic fibre mesh or by using pre-blended screeds with fibres; galvanised iron meshes are not recommended due to the excessive grip on the material and the difficult positioning at 2/3 from the bottom of the total thickness (h) of the screed.

The elasticity of the screed is also guaranteed thanks to the fractioning technique. This operation consists, when the screed has matured, in a real chequerboard fractioning, by means of flex cutting, to divide the screed into many small squares independent of each other. The dimensioning of the fractioning must be calculated according to a series of factors (type of structure, maximum load capacity, type of flooring, whether high or low frequency of passage, etc.) but usually the types of squares range from a size of 3x3 m² up to 5x5 m².

JOINTS INSULATING JOINT (EDGE STRIP)

It is an adhesive, pre-cut, peripheral insulating joint, used to separate the screed from partitions and contact with equipment and drains.

The strip serves as thermo acoustic insulating material allowing the screed to expand in the heating phase.

Especially in close proximity to floor-to-ceiling window thresholds, it greatly reduces heat transfer by conduction to the outside.

The strip is placed around the perimeter of the rooms after applying plaster, and is trimmed only after laying floor coverings.

The strip has two appendices: A lower edge acting as a foot on which the base plate rests, and a transparent PE bus bar covering the joint so that, during casting, the water in the mixture does not penetrate under the insulation. The strip should be laid at the base of bathtubs, shower trays, drains, columns and any other fixed works on the flooring system.

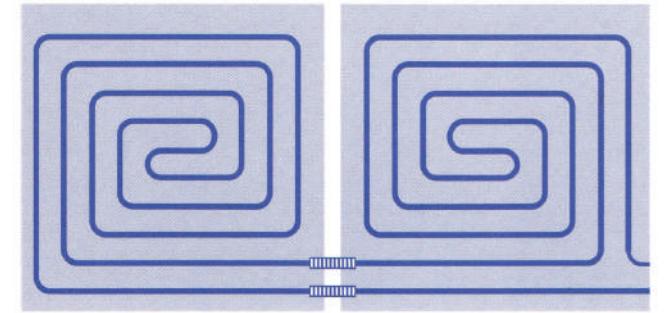
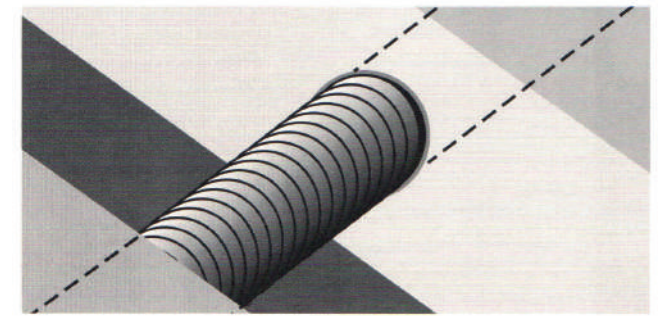

SPLITTING JOINT (OR CONTRACTION)

Following the rules of construction building, expansion joints allowing for structural extensions and contractions both horizontally and vertically must be obtained on the heating screed. To prevent unnatural movements of the adjacent plates from damaging pipes, these must be protected by a corrugated sheath in the crossings of the joints. The protective sheath must be placed

for approximately 300 mm astride the joint; in no case may the pipe cross the expansion joint for more than twice in its path (flow and return). The joint must be performed at each opening, door threshold or arc base, interposing an elastic separation baffle. The joint must also be performed by interrupting heating surfaces that exceed 40 m² or sections longer than 8 m.

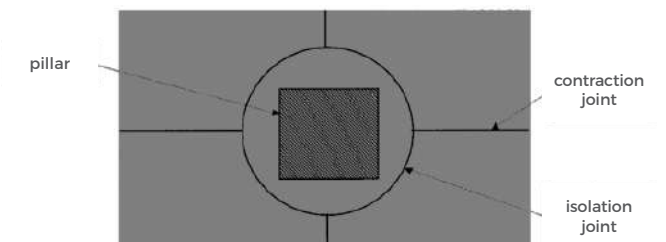
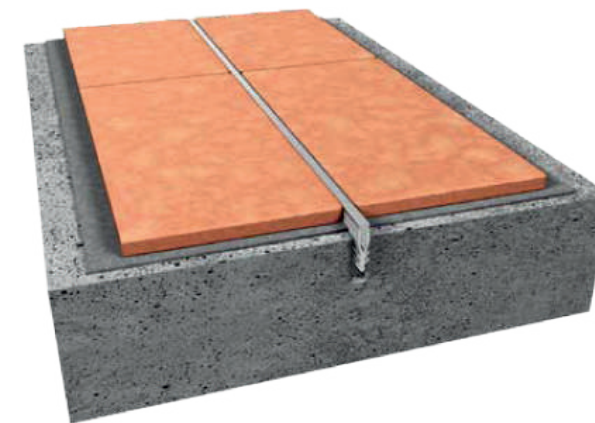

ADDITIVE: PREPARATION AND DOSAGE

For a screed to have good thermal conductivity and be able to properly incorporate the pipes it contains, concrete must have a low degree of porosity and a degree of fluidity allowing good pipe winding.

For this purpose, when preparing concrete, a fluidising additive should be used in the proportions specified below. The additive also improves concrete mechanical characteristics.

The amount of additive is foreseen for a screed thickness equal to 40÷45 mm, measured above pipes, and equal to 25÷30 mm, measured above embossments.

DOSAGE

1.2% of the cement weight. To make mixing easier, pour the additive, already pre-mixed with water, into the concrete, and continue mixing for about 10'. If a cement mixer is used, pour the additive at the construction site and mix for about 5' before starting concrete casting. If a concrete pump is used, mix for a maximum of 2'.

WATER/CEMENT RATIO

Normally the ratio is 0.5 (25 l of water per 50 kg of cement), whereas, if fluidising additive is used in the expected dosage, the water/cement ratio becomes 0.35 (16÷18 l of water for 50 kg of cement).

Store at temperatures between 5°C and 35°C. Protect from light. The product expires. Use before the date on the label. For handling, strictly follow the safety instructions.

SAFETY

For information and advice on safety as well as for using and storing chemicals, the user should refer to the most recent Safety Data Sheet containing physical, toxicological and other safety-related data.

MAKING THE SCREED: CURING TIMES

A key element for the success of a floor system is the correct implementation of the covering screed that must be:

- » mature
- » compact
- » smooth
- » planar
- » free of cracks
- » clean and dry

It is therefore essential to observe maturation time: Usually, one week per thickness centimeter or at least 28 days. It is important that no residual moisture is there to balance that of air and cement products.

In the event premixed, non-cementitious preparations are used for screeds, follow the supplier's directions. These preparations are very often sensitive to moisture, therefore the use of waterbased grout must be avoided. When curing is complete, a progressive ignition cycle of the system in heating mode must be run to test the system functionality as well as making the screed stable.

Generally, the ignition cycle is run operating the system at the minimum energy regime and increasing the temperature by 5°C per day until the maximum regime expected for operation is reached.

After keeping the maximum temperature for at least 5 days, proceed backwards, i.e. decrease by 5°C per day, until room temperature is reached.

The screed, subjected to this cycle, frequently causes the appearance of cracks that must be evaluated. The heating starting process must be documented.

In the case of screed coats, it is usually appropriate to use a suitable additive to increase the compaction degree and consequently improve mechanical characteristics and thermal conductivity.

If pre-mixed or pre-dosed products for heating/cooling systems are used, no additives should be employed, following, in any case, the supplier's instructions.

The installer is responsible for checking the humidity degree in the screed before laying the coating.

In screeds with heating/cooling elements, in addition to the requirements for floating screeds, a minimum screed thickness value of at least 3 cm must be provided for above the heating/cooling elements, as required by EN 1264.

If maturation time is not observed, tensions are created that may cause tiles to lift if the strength of individual layers is exceeded. These voltages increase as the tiles, much so if porous, tend to expand due to water absorption (moisture and washes). To overcome this drawback, it is appropriate to provide for edge and expansion joints. In addition, to avoid creating excessive tension, the screed must be detached from the supporting structure.

The result is a "separated" screed. Floating screeds, precisely because they do not adhere to the support, are subject to deformation caused by their shrinkage.



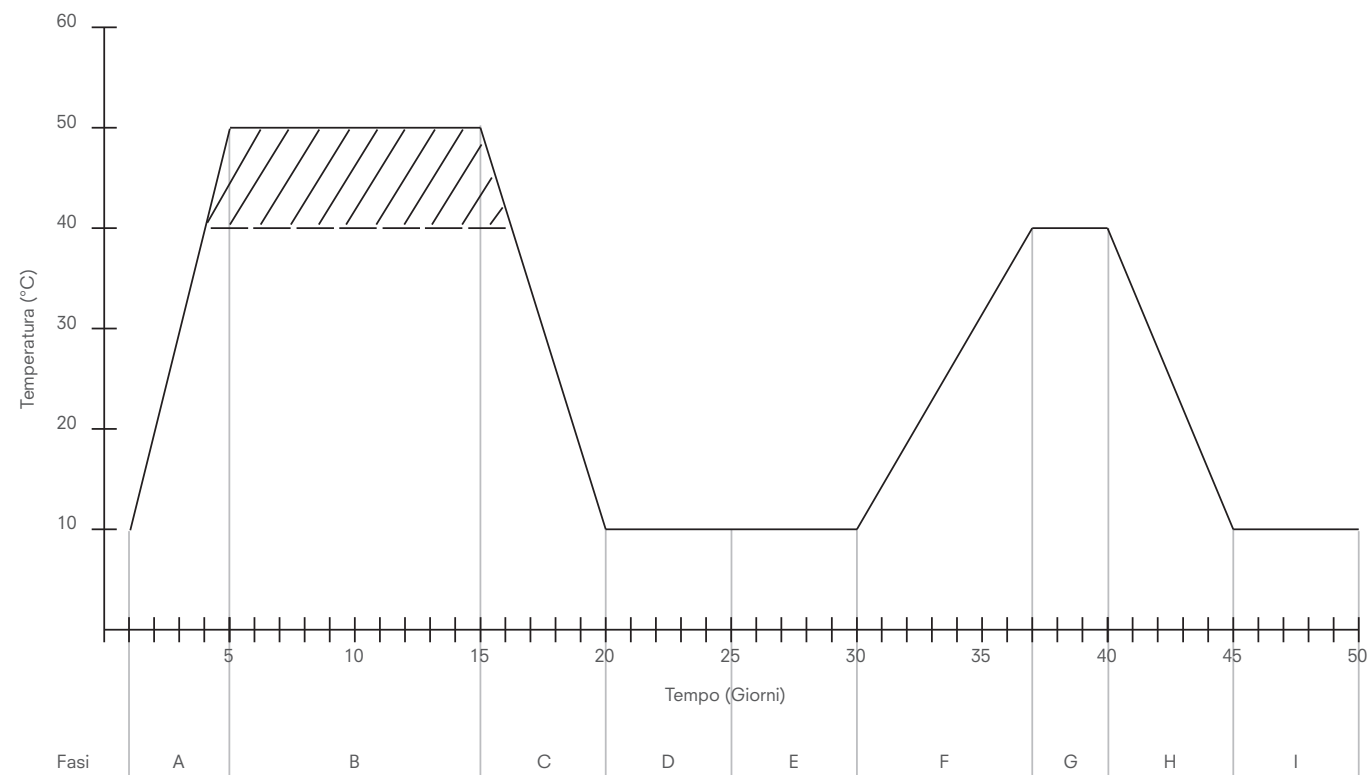

LEGENDA

- Key:
- A. Ignition of the system in heating mode in 10°C increments per day until the maximum temperature is reached;
 - B. Keeping the system at the maximum temperature for 10 days;
 - C. Gradual shutdown of the system with 10°C decreases per day until room temperature is reached;
 - D. Stabilisation of the pre-laying temperature;
 - E. Laying the flooring;
 - F. Gradual ignition of the system in heating mode, in 6÷7 days;
 - G. Keeping the system at the operating temperature for 2÷3 days;
 - H. Gradual shutdown of the system in 4÷5 days;
 - I. Finishing.

THERMAL INSULATION

The base plate's main function for heating and cooling flooring systems is lower thermal insulation. Thermal insulation is critical to ensure optimum performance and significant energy savings.

According to EN 1264, insulating layers must have the following minimum thermal resistance depending on the thermal conditions underlying the floor heating structure.

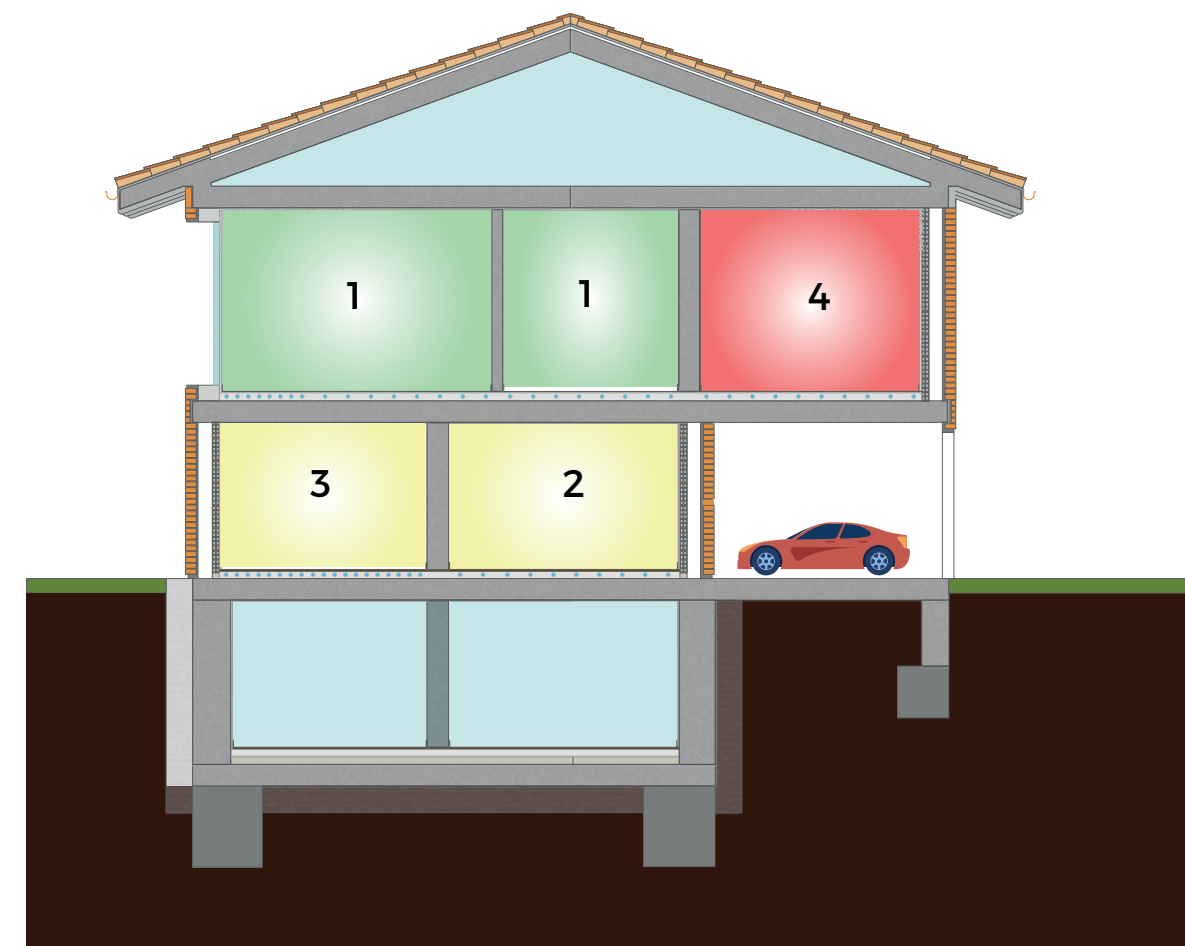

	ROOM 1	ROOM 2 / 3	ROOM 4		
	Underlying Ambient heated	Underlying ambient not heated or heated but not continuously or directly by floor	External Project Temperature >0°C	External Project Temperature -5 / 0°C	External Project Temperature -15 / -5°C
INTERNAL TEMPERATURE T _i (°C)	20	20	20	20	20
THERMAL RESISTANCE R _λ (m ² K/W)	0.75	1.25	1.25	1.50	2.00



VARMO FORM

THERMOFORMED
INSULATING PANEL



VARMO FORM

THERMOFORMED INSULATING PANELS

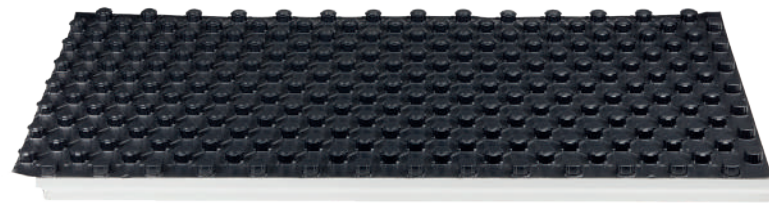

VARMO FORM insulating panels, made with solid bosses in sintered expanded polystyrene, are ideal for the construction of radiant heating systems. It is a versatile and resistant system. The bosses have an undercut to ensure the stable position of the tube and prevent horizontal and vertical movements. The interlocking rigid coating film acts as a vapor barrier and gives the bosses mechanical strength. The installation is facilitated thanks to the lateral overlap with pressure coupling that guarantees a perfect seal against thermal bridges and self-leveling screeds. It complies with the regulations in force regarding thermal insulation and with UNI EN 13163 of 2009 and UNI EN 1264-4 standards; it has CE marking

CODE	Ø	✱	◇	📦
PI00VFN321022H	1400x800	32 (10+22) mm	-	22
PI00VFN422022H	1400x800	42 (20+22) mm	-	16
PI00VFN523022H	1400x800	52 (30+22) mm	-	12
PI00VFN624022H	1400x800	62(40+22) mm	-	10
PI00VFN725022H	1400x800	72 (50+22) mm	-	8
PI00VFN826022H	1400x800	82 (60+22) mm	-	-

ADVANTAGES

- Quick and easy to install
- Immediate walkability of the floor after installation
- No limitations on the choice of floor coverings
- Mechanical strength
- Perfect resistance to thermal bridges and self-leveling screeds

PANEL GUIDE

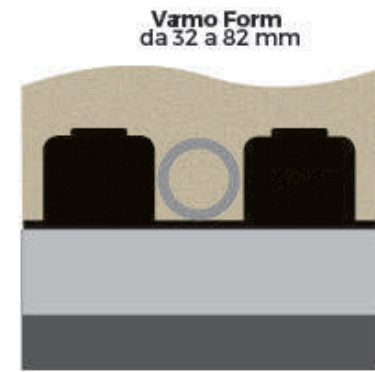



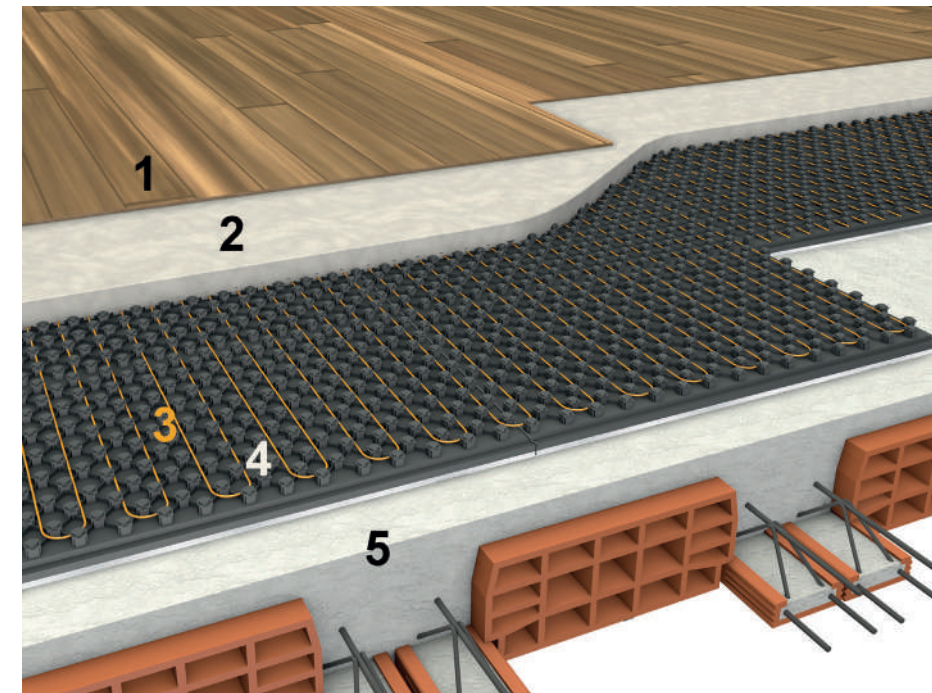



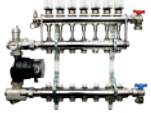

LEGEND	REFERENCE
	Screed
	Insulating
	Solothurn

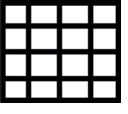

LEGEND	DESCRIPTION
1	Floor covering
2	Screed
3	Pipe
4	Varmo Form panel
5	Stable solid and flat substrate

	PI00VFN321022H	PI00VFN422022H	PI00VFN523022H	PI00VFN624022H	PI00VFN725022H	PI00VFN826022H
Insulation height (mm)	10	20	30	40	50	60
TOTAL Height (mm)	32 (10 + 22)	42 (20 + 22)	52 (30 + 22)	62 (40 + 22)	72 (50 + 22)	82 (60 + 22)
Total panel size (mm)	1.400 x 800 (1.120 m ²)					
Pipes	16-17					
Panels per pack (n). Minimum quantity	22	16	12	10	8	7
m ² per pack	24.64	17.92	13.44	11.2	8.96	7.84
Thermal conductivity EN 12 667 W/mK	0.033	0.034				
Declared thermal resistance Rd (m ² K / W)	0.45	0.74	1.03	1.32	1.62	1.91
Density (EPS) (kg / m ³)	200	150				
Minimum installation pitch (mm)	50					
Resistant to fire EN 13501-1	Euroclass E					
Resistant to compression at 10% deformation EN 826 (KPa)	200	150				
Resistance to vapor diffusion EN 12086 (μ)	40-100	30-70				

COMPONENTS		
	Mixing unit	P. 127
	Distribution manifolds	P. 155
	Pipes	P. 103
	Pipe clip	P. 106
	Perimeter edging	P. 107
	Expansion joint	P. 107
	Elbow	P. 106
	Stabilizer network	P. 108
	Vapor barrier	P. 106
	Additive	P. 105

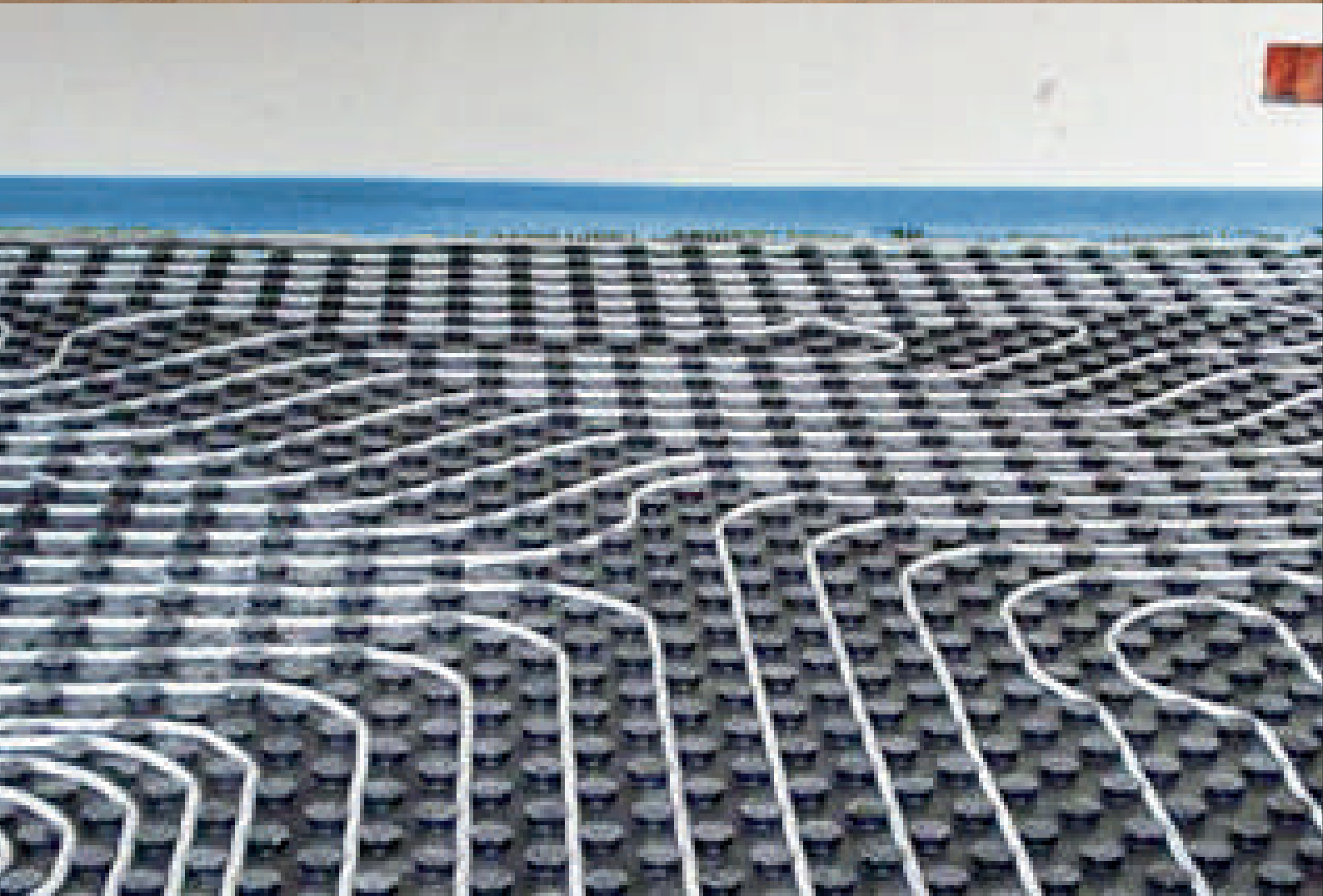

VARMO FORM-GRAFITE

THERMOFORMED
INSULATION PANELS
ADDITIVATED WITH
GRAPHITE



VARMO FORM GRAFITE

THERMOFORMED INSULATING PANELS WITH GRAPHITE

VARMO FORM insulating panels, made with solid bosses in sintered expanded polystyrene with graphite, are ideal for the construction of radiant heating systems. It is a versatile and resistant system. The use of this particular material, formed from classic expanded polystyrene processed with graphite, makes it possible to achieve unparalleled levels of thermal insulation, even with minimal thickness. The conformed ashlars are suitable and arranged to allow the installation of 16- and 17-diameter pipes with 50mm pitch. It complies with the regulations in force regarding thermal insulation and with UNI EN 13163 of 2009 and UNI EN 1264-4 standards; it has CE marking.

CODE	Ø	✱	◇	📦
PI00VGN321022H	1400x800	32 (10+22) mm	-	22
PI00VGN452322H	1400x800	45 (23+22) mm	-	14
PI00VGN603822H	1400x800	60 (38+22) mm	-	10
PI00VGN674522H	1400x800	67(45+22) mm	-	8
PI00VGN826022H	1400x800	82 (60+22) mm	-	7

ADVANTAGES

- High performance, due to the characteristics of the graphitic material, optimal thermal insulation is achieved even with minimal thicknesses
- Quick and easy to install
- Immediate walkability of the floor after installation
- No limitations on the choice of floor coverings
- No load sharing
- Layable on pre-existing pavements
- Perfect resistance to thermal bridges and self-leveling screeds

PANEL GUIDE





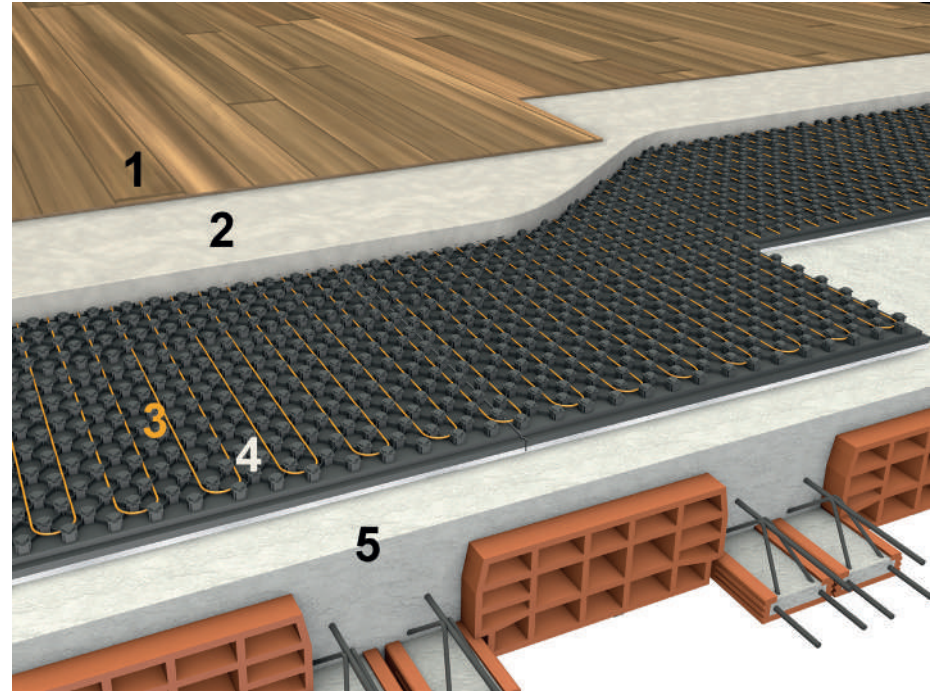





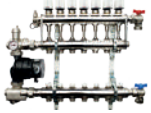

LEGEND	REFERENCE
	Screed
	Insulating
	Solothurn



LEGEND	DESCRIPTION
1	Floor covering
2	Screed
3	Pipe
4	Varmo Form Grafite panel
5	Stable solid and flat substrate

	PI00VGN321022H	PI00VGN452322H	PI00VGN603822H	PI00VGN674522H	PI00VGN826022H
Insulation height (mm)	10	23	38	45	60
TOTAL Height (mm)	32 (10 + 22)	45 (23 + 22)	60 (38 + 22)	67 (45 + 22)	82 (60 + 22)
Pipes	16-17				
Total panel size (mm)	1.400 x 800 (1.120 m ²)				
Panels per pack (n). Minimum quantity	22	14	10	8	7
m ² per pack	24.64	15.68	11.2	8.96	7.84
Thermal conductivity EN 12 667 W/mK	0.03				
Declared thermal resistance Rd (m ² K / W)	0.33	0.77	1.27	1.5	2
Density (EPS) (kg / m ³)	200	150			
Minimum installation pitch (mm)	50				
Resistant to fire EN 13501-1	Euroclasse E				
Resistant to compression at 10% deformation EN 826 (KPa)	200	150			
Resistance to vapor diffusion EN 12086 (μ)	30-70	50-90			

COMPONENTS	COMPONENTS	COMPONENTS
	MIXING UNIT	P. 127
	Manifolds	P. 155
	Pipes	P. 103
	Pipe clip	P. 106
	Perimeter edging	P. 107
	Expansion joint	P. 107
	Elbow	P. 106
	Stabilizer network	P. 108
	Vapor barrier	P. 106
	Additive	P. 105



VARMO WELD

THERMOFORMED
INSULATING PANEL

VARMO WELD

HEAT-SEALED INSULATING PANELS

VARMO WELD insulating panels are made of sintered expanded polystyrene. They are extremely versatile and designed for laying pipes from 16 to 17 mm in diameter. They are equipped with interlocking perimeter edges. VARMO WELD panels are coated with black thermoplastic film with a vapor barrier function. Installation is easy and immediate, guaranteeing speed of installation. It complies with the regulations in force regarding thermal insulation and with UNI EN 13163 of 2009 and UNI EN 1264-4 standards; it has CE marking.

CODE	Ø	✱	◇	📦
PI00VWN401525H	1400x800 mm	40 (15+25)mm	-	18
PI00VWN452025H	1400x800 mm	45 (20+25)mm	-	16
PI00VWN553025H	1400x800 mm	55(30+25)mm	-	12



ADVANTAGES

- Can be laid on pre-existing floors
- Quick and easy to install
- Immediate walkability of the floor after installation
- No limitations on the choice of floor coverings

PANEL GUIDE

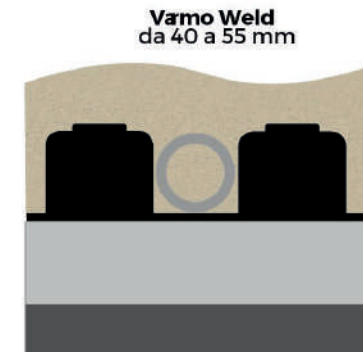



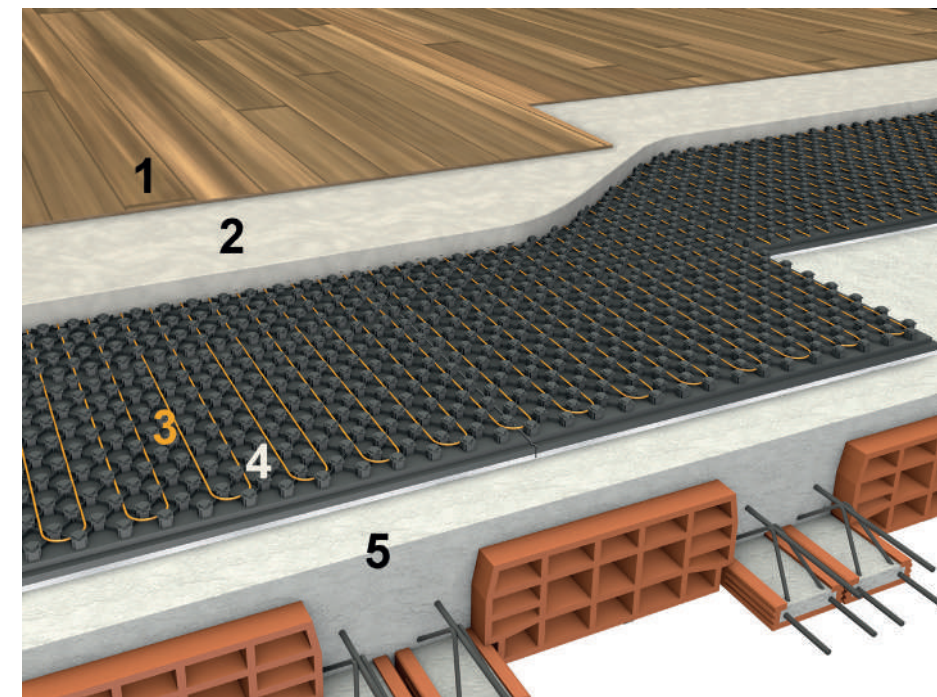



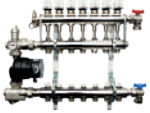

LEGEND	REFERENCE
	Screed
	Insulating
	Solothurn

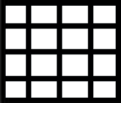

LEGEND	DESCRIPTION
1	Floor coating
2	Screed
3	Pipe
4	Varmo Weld Panel
5	Substrate

	PI00VWN401525H	PI00VWN452025H	PI00VWN553025H
Total Height (mm)	40 (15+25)	45 (20+25)	55 (30+25)
Pipes (mm)	16-17		
Total panel size (mm)	1400 x 800 mm (1.12 m ²)		
Panels per pack (n). Minimum quantity	14	11	9
m ² per pack	20.16	17.92	13.44
Thermal conductivity EN 12 667 W/mK	0.034		
Declared thermal resistance Rd (m ² K / W)	0.8	1.15	1.45
Cover film	Black thermoformed cover film		
Density (EPS) (kg / m ³)	K150		
Minimum installation pitch (mm)	50		
Fire resistant EN 13501-1	Euroclass E		
Resistant to compression at 10% deformation EN 826 (KPa)	150		
Resistance to vapor diffusion EN 12086 (μ)	30-70		

COMPONENTS	COMPONENTS	COMPONENTS
	Mixing unit	P. 127
	Manifolds	P. 155
	Pipes	P. 103
	Pipe clip	P. 106
	Perimeter edging	P. 107
	Expansion joint	P. 107
	Elbow	P. 106
	Stabilizer network	P. 108
	Vapor barrier	P. 106
	Additive	P. 105



VARMO FLAT

FLAT INSULATION PANEL

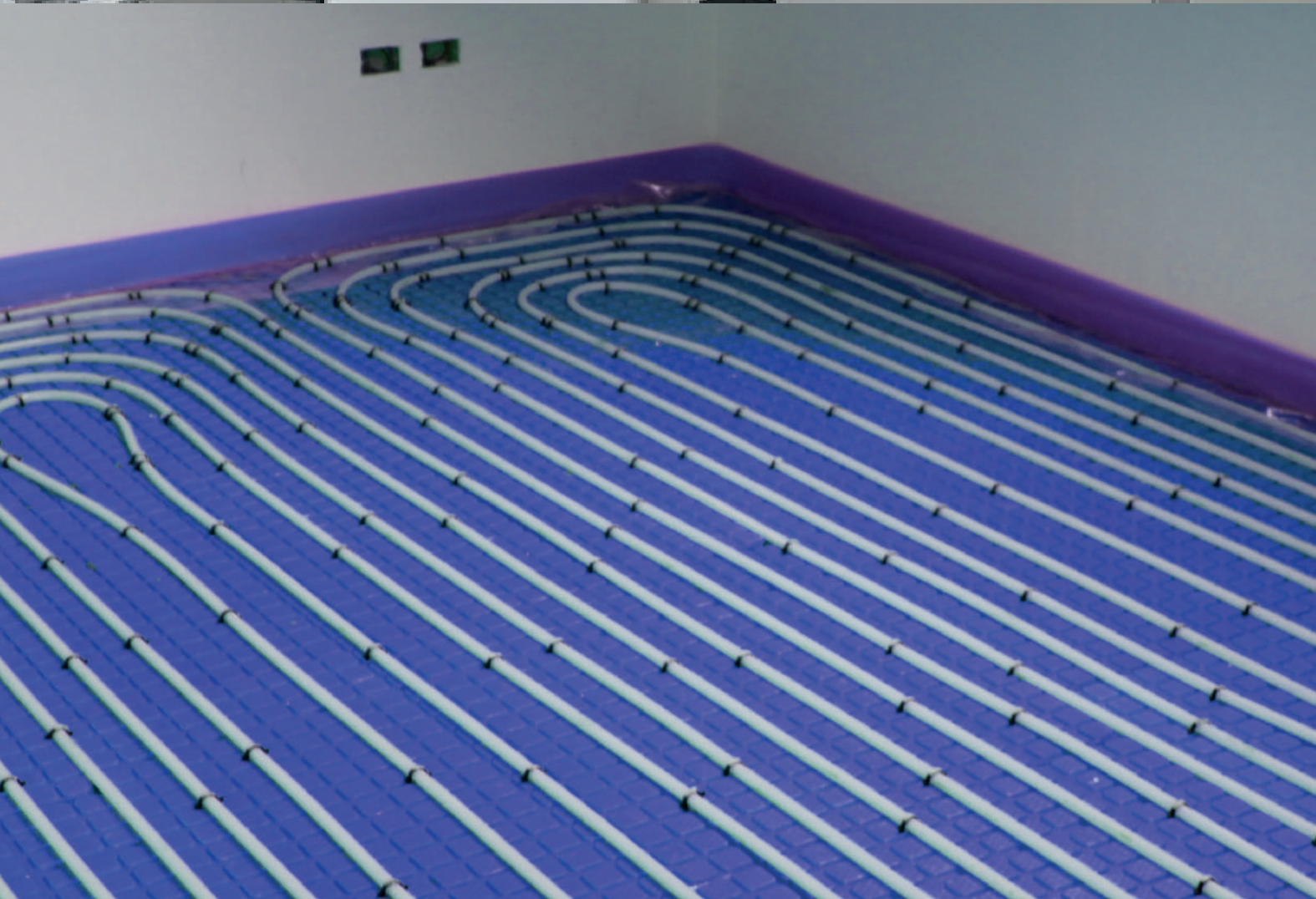

VARMO FLAT

FLAT INSULATING PANELS



Insulating panels in sintered expanded polystyrene, with interlocking perimeter edges and covered with blue thermoplastic film.
 The film acts as a vapor barrier.
 The geometry of the bas-relief panels helps the positioning of pipes of any diameter.

CODE	Ø	✱	◇	📦
PI00VPB200000H	1400x800 mm	20 mm	-	26
PI00VPB300000H	1400x800 mm	30 mm	-	17
PI00VPB400000H	1400x800 mm	40 mm	-	13

ADVANTAGES

- Can be laid on pre-existing floors
- Quick and easy to install
- Immediate walkability of the floor after installation
- Suitable for industrial plants or with heavy loads
- No limitations on the choice of floor coverings
- Positioning of the pipes facilitated by the geometry of the bas-relief panels

PANEL SECTION GUIDE

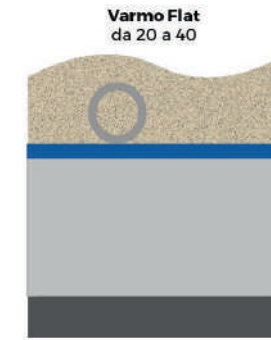



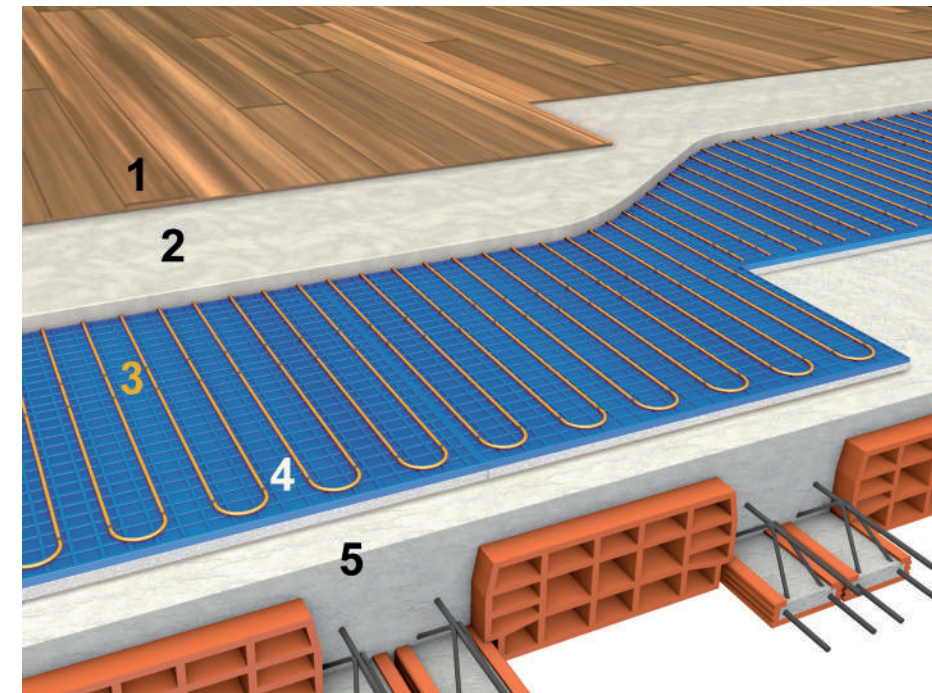



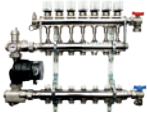
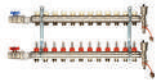

LEGEND	REFERENCE
	Screed
	Insulating
	Solothurn

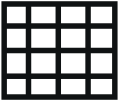

LEGEND	DESCRIPTION
1	Floor covering
2	Screed
3	Pipe
4	Varmo Flat panel
5	Stable solid and flat substrate

	PI00VPB200000H	PI00VPB300000H	PI00VPB400000H
Insulation Height (mm)	20	30	40
Pipes (mm)	tutte		
Total panel size (mm)	1400 x 800 mm (1.12 m ²)		
Panels per pack (n). Minimum quantity	26	17	13
m ² per pack	29.12	19.04	14.56
Thermal conductivity EN 12 667 W/mK	0.032		
Declared thermal resistance Rd (m ² K / W)	0.62	0.94	1.25
Cover film	Blue thermoformed cover film		
Density (EPS) (kg / m ³)	K300		
Minimum installation pitch (mm)	50		
Fire resistant EN 13501-1	Euroclass E		
Resistant to compression at 10% deformation EN 826 (KPa)	300		
Resistance to vapor diffusion EN 12086 (μ)	50-110		

COMPONENTS	COMPONENTS	COMPONENTS
	Mixing unit	P. 127
	Manifolds	P. 155
	Pipes	P. 103
	Pipe clip for bossed	P. 106
	Bar	P. 105
	Perimeter edging	P. 107
	Expansion joint	P. 107
	Elbow	P. 106
	Stabilizer network	P. 108
	Vapor barrier	P. 106
	Additive	P. 105



VARMO ROLL

INSULATION PANEL
IN ROLLS



VARMO ROLL

ROLL INSULATION PANELS

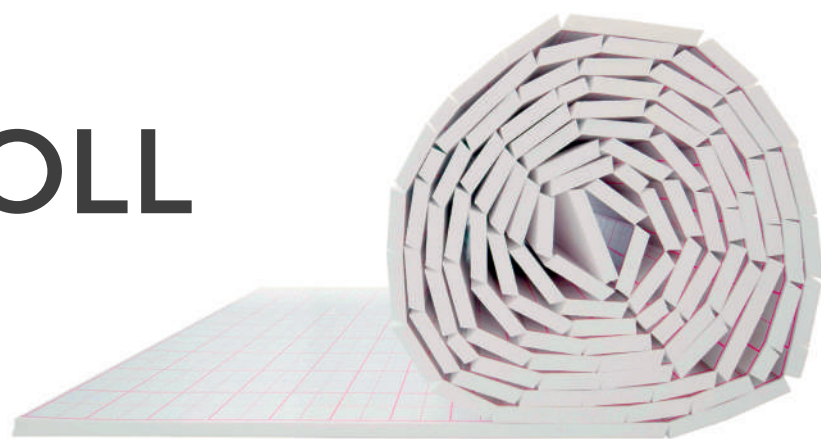

Insulating panels in closed cell expanded polystyrene, with self-adhesive perimeter edges and covered with reflective aluminised sheath with laying step tracing.
The film acts as a vapor barrier.
The geometry of the squares printed on the heat-reflecting film helps the laying of pipes of any diameter.

CODE	Ø	✱	◇	◻
PI00VRW200000H	10x1m	20 mm	-	-
PI00VRW300000H	10x1m	30 mm	-	-
PI00VRW400000H	8x1m	40 mm	-	-

ADVANTAGES

- Can be laid on pre-existing floors
- Quick and easy to install
- Immediate walkability of the floor after installation
- Heat-reflecting film with frame geometry that facilitates the laying of pipes
- No limitations on the choice of floor coverings
- Versatile, without constraints given by bosses, maximum flexibility in laying the pipe
- Optimal heat distribution, with the pipe completely embedded in the screed

SECTION

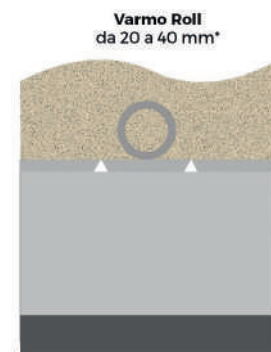

LEGEND	REFERENCE
	Screed
	Insulating
	Solothurn

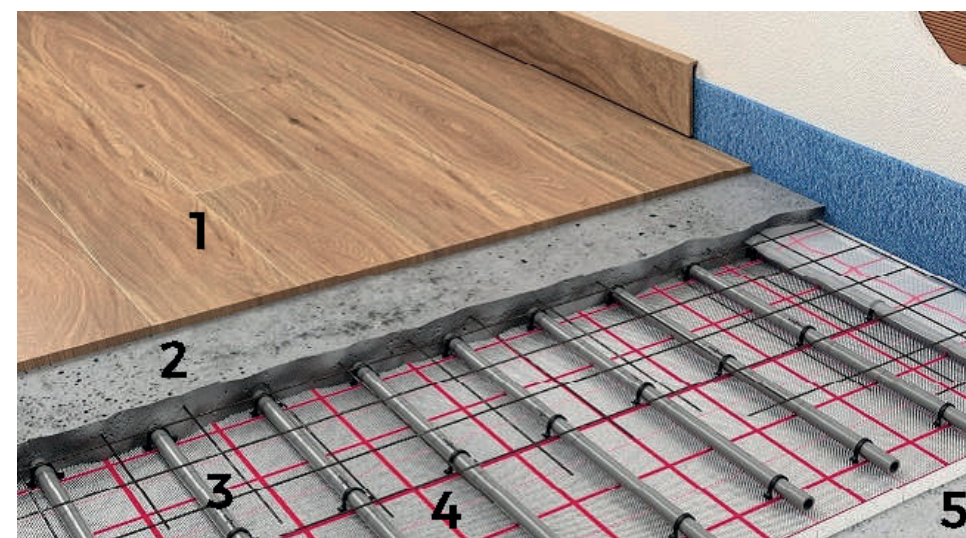







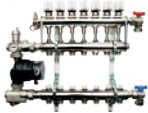
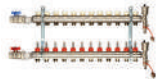

LEGEND	DESCRIPTION
1	Floor covering
2	Screed
3	Pipe
4	Varmo Roll panel
5	Stable solid and flat substrate

TECHNICAL INFORMATION

	PI00VRW200000H	PI00VRW300000H	PI00VRW400000H
Insulation Height (mm)	20	30	40
Pipes (mm)	pipes		
Total panel size (mm)	10.000x1.000 (10 m ²)		8.000x1.000 (8 m ²)
Thermal conductivity EN 12 667 W/mK	0.034		
Declared thermal resistance Rd (m ² K / W)	Aluminized sheath		
Density (EPS) (kg / m ³)	K150		
Minimum installation pitch (mm)	50		
Fire resistant EN 13501-1	Class F (Class E insulation only)		
Resistant to compression at 10% deformation EN 826 (KPa)	150		

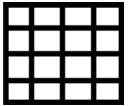
COMPONENTS

COMPONENTS	COMPONENTS	COMPONENTS
	Mixing unit	P. 127
	Manifolds	P. 155
	Pipes	P. 103
	Pipe clip for bossed	P. 106
	Bar	P. 106
	Perimeter edging	P. 107
	Expansion joint	P. 107
	Elbow	P. 106
	Stabilizer	P. 108
	Barrier	P. 106
	Additive	P. 105



VARMO TECK

LOW THICKNESS
RADIANT SYSTEM

VARMO TECK 23-28



LOW THICKNESS RADIANT SYSTEM

VARMO TECK 23-28 is the radiant panel for underfloor heating systems designed for renovations when there are height problems to fit a traditional radiant floor system. In fact, with VARMO TECK 23-28, it is possible to create a new underfloor heating system in only 4.5 cm unlike traditional systems that require at least 8-10 cm. Can be used with pipes of the following diameters: 16-17 mm.

VARMO TECK 23-28 can be used in public and private environments, in dry places and in environments at risk of moisture exposure, such as bathrooms and kitchens.

If a self-levelling screed is used, VARMO TECK 23-28 has a very low inertia, which allows very precise thermoregulation and fast set-up, resulting in savings in operating costs due to lower energy consumption.

CODE	Ø	↔	◇	◻
PI00VTN230518H	1450x850 mm	23 mm	-	-
PI00VTN281018H	1450x850 mm	28 mm	-	-

ADVANTAGES

- Possibility to make a finished system in only 45 mm (depending on the screed)
- Reduced masonry work: VARMO TECK 23-28 can be laid directly on old floors, avoiding costly demolition and disposal work
- Speed of laying: the special design of the bosses allows for practical and fast laying; in fact, no clips are required to hold the pipe in place
- Energy saving
- Ideal for renovations
- No limitations on the choice of floor coverings



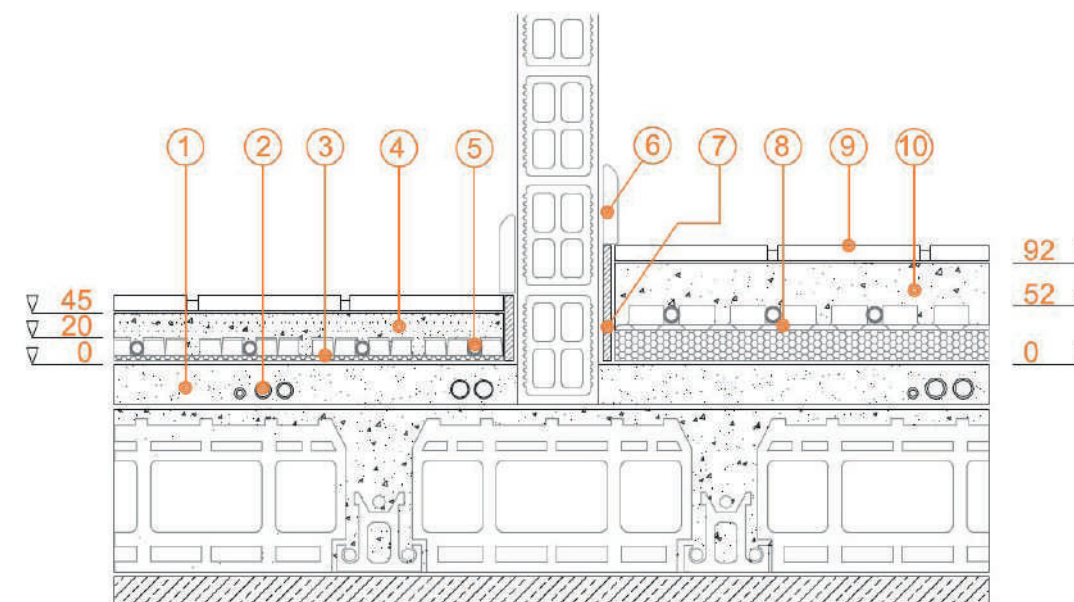



VARMO TECK COMPARISON WITH RADIANT SYSTEM TRADITIONAL

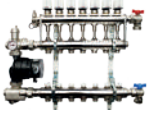

LEGEND

1	Containment screed technical facilities
2	Electrical system / sanitary system adductions
3	VARMO TECK PANEL
4	Specific screed for low-thickness systems
5	Pipe
6	Skirting boards
7	Perimeter edging
8	Traditional panel
9	Flooring
10	Traditional screed for radiant systems

	PI00VTN230518H	PI00VTN281018H
Insulation height (mm)	5	10
Insulation height + bosses (pipe blocking element), mm	23 (5 + 18)	28 (10 + 18)
Pipes (mm)	16 - 17	
Pipes (mm)	1450x850	
Useful panel size (mm)	1400x800	
Panels per pack (n). Minimum quantity	12	24
m ² per pack	13.44	26.88
Thermal conductivity EN 12 667 W/mK	0.032	
Declared thermal resistance Rd (m ² K / W)	0.16	0.31
Density (EPS) (kg / m ³)	400	300
Minimum installation pitch (mm)	50 + diag.	
Resistan to fire EN 13501-1 EN 13501-1	Euroclass E	
Resistant to compression at 10% deformation EN 826 (KPa)	400	300
Resistance to vapor diffusion EN 12086 (μ)	50-110	

COMPONENTS	COMPONENTS	COMPONENTS
	Mixing unit	P. 127
	Manifold	P. 155
	Pipes	P. 103
	Perimeter edging	P. 107
	Expansion joint	P. 107
	Elbow	P. 106

LAYING TIPS

SUBSTRATE PREPARATION

Before VARMO TECK is laid, a leveling layer is often cast, in which the electrical and sanitary systems usually find their place. From the surface of this level should be removed irregularities and the surface should be cleaned, before the laying of the panels. At all vertical walls the perimeter band should be laid in order to avoid thermal bridges and to cushion any expansion of the screed. The laying of the pipe is then carried out.

PIPE LAYING AND CIRCUIT MAKING

The pipe can be laid in different ways; there is no need to worry about any small counter slopes, as they do not adversely affect circulation.

Laying the spiral pipe is always advisable as it allows uniform temperature over the entire surface and the circuit can be made with only 2 "180°" bends (where there is inversion of the spiral) making it easier for the installer also with reduced spacing. With the spiral, there is no need to orient the supply to the most dispersing walls.

In the coil-laying system, on the other hand, the temperature decreases between the beginning and end of the circuit, and the many 180° bends make the laying work unnecessarily burdensome.

In large rooms or areas (greater than 40m²), the use of the perimeter edge is not sufficient and the use of expansion joints is recommended.

As for the distribution system, circuits are, most of the time, connected to double collectors, placed in inspectable boxes.

In the area close to the manifold there is often considerable thickening of piping, which in some cases makes it necessary to insert insulating sheaths to prevent excessive heating of the floor above.

MAKING SCREED AND LAYING FLOORING

When casting the screed, it is advisable to keep water under pressure in the pipes (4 bar). The proportions of the mix needed to make the screed depend on the desired strength class and the grain size of the aggregates used

Any flooring can be used; it is only necessary to know the characteristics of the flooring in order to accurately determine the performance of the panel.

Make sure before laying the floor finish that the screed is well dry, possibly run the system for 2-3 days before laying, especially if parquet is to be laid.



VARM TECK-0

LOW THICKNESS
RADIANT SYSTEM



VARMO TECK 0

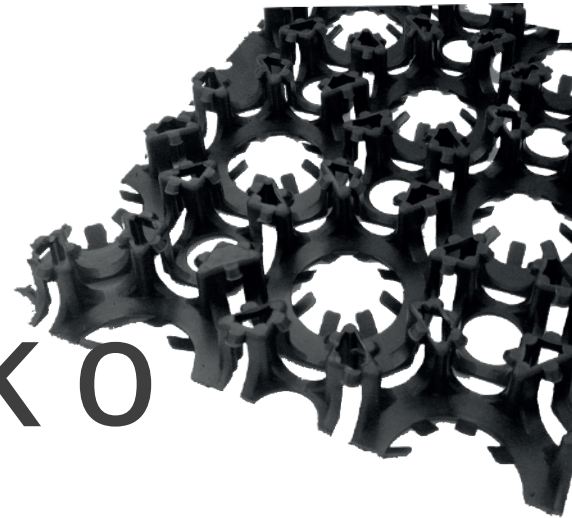

LOW THICKNESS RADIANT SYSTEM

VARMO TECK 0 is an insulation panel for radiant floor systems with low thickness, made of polypropylene (100% recycled plastic material) injection molded.

VARMO TECK 0 is recommended for renovations, also with already existing flooring, where there is little thickness or in situations requiring a low-inertia system to facilitate the management of the system itself, favoring faster start-up than a traditional system and thus improving consumption. The panel measures 841x641mm with embossed bosses 18.5 mm high. The useful surface area is 0.48sqm, the total surface area is 0.54sqm. It is provided on the 4 sides of the panel the overlap of 41mm interlocking for panel sealing during installation.

It is suitable for pipes with a minimum diameter of 16-17mm to a maximum of 18mm, allowing laying with 50mm pitch spacing and diagonal.

CODE	∅	*	i	◇	□
PI00VTN18CA18H	841x641 mm	18.5 mm	with adhesive	-	-
PI00VTN18SA18H	841x641 mm	18.5 mm	without adhesive	-	-





ADVANTAGES

- Reduced thickness radiant system in less than 30 mm.
- Reduced masonry work: VARMO TECK 0 can be laid directly on old flooring, avoiding costly demolition and disposal work
- Reduced and self-levelling screeds
- Low thermal inertia: the desired temperature is reached in a very short time
- Energy saving
- Immediate walkability of the floor after installation
- Ideal for renovations

TECHNICAL INFORMATION

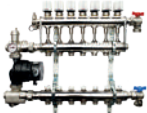
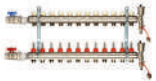
	PI00VTN18CA18H WITH ADHESIVE	PI00VTN18SA18H WITHOUT ADHESIVE
Insulation height (mm)	18.5	
Laying pitch (mm)	50	
Pipes (mm)	16-17	16-17
Total panel size (mm)	841x641	
Useful panel size (mm)	800x600	
Panels per pack (n). Minimum quantity	20	
Useful area	0,48 m ²	
m ² per pack	9,60 m ²	
Density (EPS) (kg / m ³)	500	
Minimum installation pitch (cm): 5-10-15	50 mm also at 45°	
Resistant to fire EN 13501-1	Euroclass E	
Resistant to compression at 10% deformation EN 826 (KPa)	500	

COMPONENTS

COMPONENTS	COMPONENTS	COMPONENTS
	Mixing unit	P. 127
	Manifold	P. 155
	Pipes	P. 103
	Perimeter edging	P. 107
	Expansion joint	P. 107
	Elbow	P. 106

PANEL GUIDE

Wet solution - self-levelling screed (3 mm above the pipe) - dry according to UNI EN 1264 - regenerated loaded PP-R mesh.
Laying pitch: 5cm



LAYING TIPS

Lay the panel on the flat (clean and smooth) surface by interlocking the slabs with each other through the hooks located on the 41 mm perimeter band, or attach to the slab through the 8 holes present on the bedding surface.



VARMO ALU

INSULATING HEAD AND
PANEL IN EXPANDED
POLYSTYRENE COVERED
WITH ALUMINIUM SHEET

VARMO ALU



INSULATING HEAD AND PANEL IN EXPANDED POLYSTYRENE COVERED WITH ALUMINIUM SHEET

Expanded polystyrene panel covered with a removable aluminum sheet 0.3 mm thick. VARMO ALU radiant floor heat system consists of a panel, head, polyethylene sheet and galvanized steel sheets which together form a low inertia system, without the need for a screed. Ideal for systems with 16 - 17 mm pipe. Place the vapor barrier between the galvanized steel plate and the panel.

CODE	Ø	✱	◇	📦
PI00VAH126028H	1200x600 mm	28 mm	-	16
PI00VAH603028H	600x300 mm	28 mm	-	32
PI00VAH603001H	600x300 mm	1 mm	-	10
PI00VAH6030A1H	600x300 mm	1 mm	-	10
PI00VAH606001H	600x600 mm	1 mm	-	10
PI00VAH6060A1H	600x600 mm	1 mm	-	10

VAPOR BARRIER CODE	Ø	◇	📦
BV0000H100000H	100 m2	-	-

ADVANTAGES

- Can be laid on pre-existing floors
- No limitations on the choice of floor coverings
- Heat-reflecting film with frame geometry that facilitates the laying of pipes

SECTION GUIDE

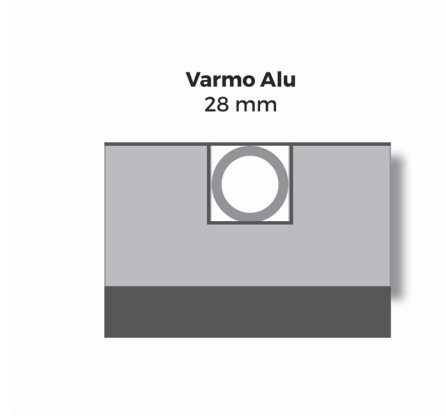



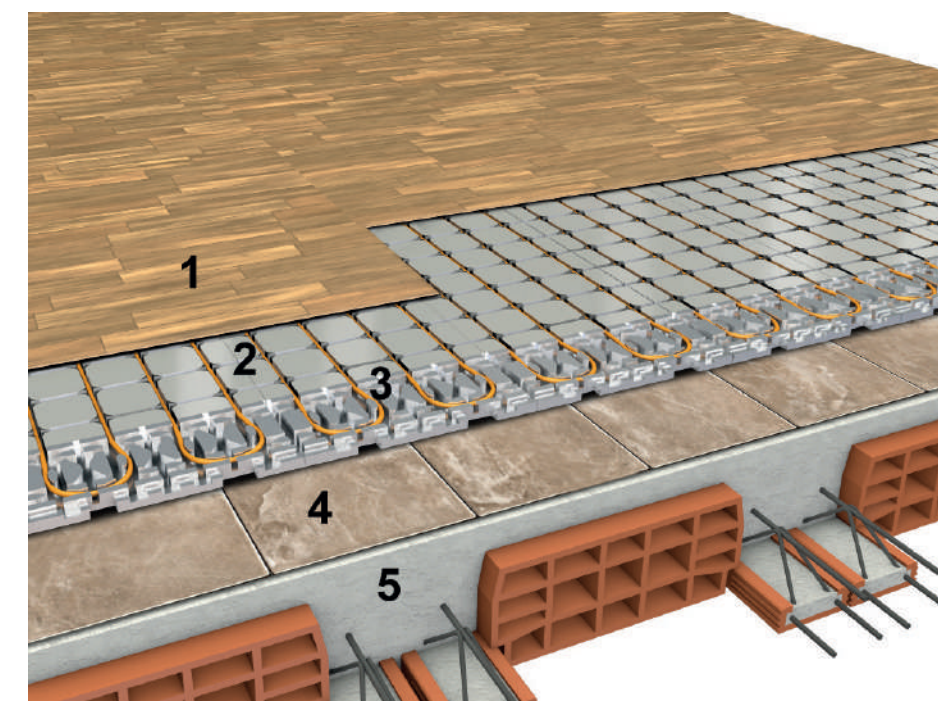



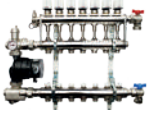

LEGEND	REFERENCE
	Screed
	Insulating
	Solothurn



LEGEND	DESCRIPTION
1	Floor covering
2	Varmo Alu panel
3	Pipe
4	Pre-existing flooring
5	Subfloor

	POLYSTYRENE INSULATION PANEL COVERED WITH ALUMINIUM SHEET	POLYSTYRENE HEAT INSULATION PANEL COVERED WITH ALUMINIUM SHEET	GALVANIZED PLATE
TOTAL HEIGHT (mm)	28		1
Total panel size (mm)	1200 x 600	600 x 300	600 x 600 600 x 300 600 x 600 WITH ADHESIVE 600 x 300 WITH ADHESIVE
Pipes (mm)	16-17		
Panels per pack (n). Minimum quantity	16	32	10
m ² per pack	11.52	5.76	1,80/3,60
Thermal conductivity EN 12 667 W/mK	0.033		-
Cover film	Aluminum 0,3 mm		-
Declared thermal resistance Rd (m ² K / W)	0.65		-
Density (EPS) (kg / m ³)	K200		-
Minimum installation pitch (mm)	150		
Fire resistant EN 13501-1 EN 13501-1	Class E		-
Resistant to compression at 10% deformation EN 826 (KPa)	≥ 200		-
Resistance to vapor diffusion EN 12086 (μ)	40-100		-
Specific heat capacity EN 10456 8 (J / kgK Cp)	1450.000		-
Coefficient of linear thermal expansion K	65 X 10 ⁻⁴		-
Limit operating temperature (°C)	80		-

COMPONENTS	COMPONENTS	COMPONENTS
	Mixing unit	P. 127
	Manifolds	P. 155
	Pipes	P. 103
	Perimeter edging	P. 107
	Expansion joint	P. 107
	Elbow	P. 106
	Vapor barrier	P. 106
	Additive	P. 105

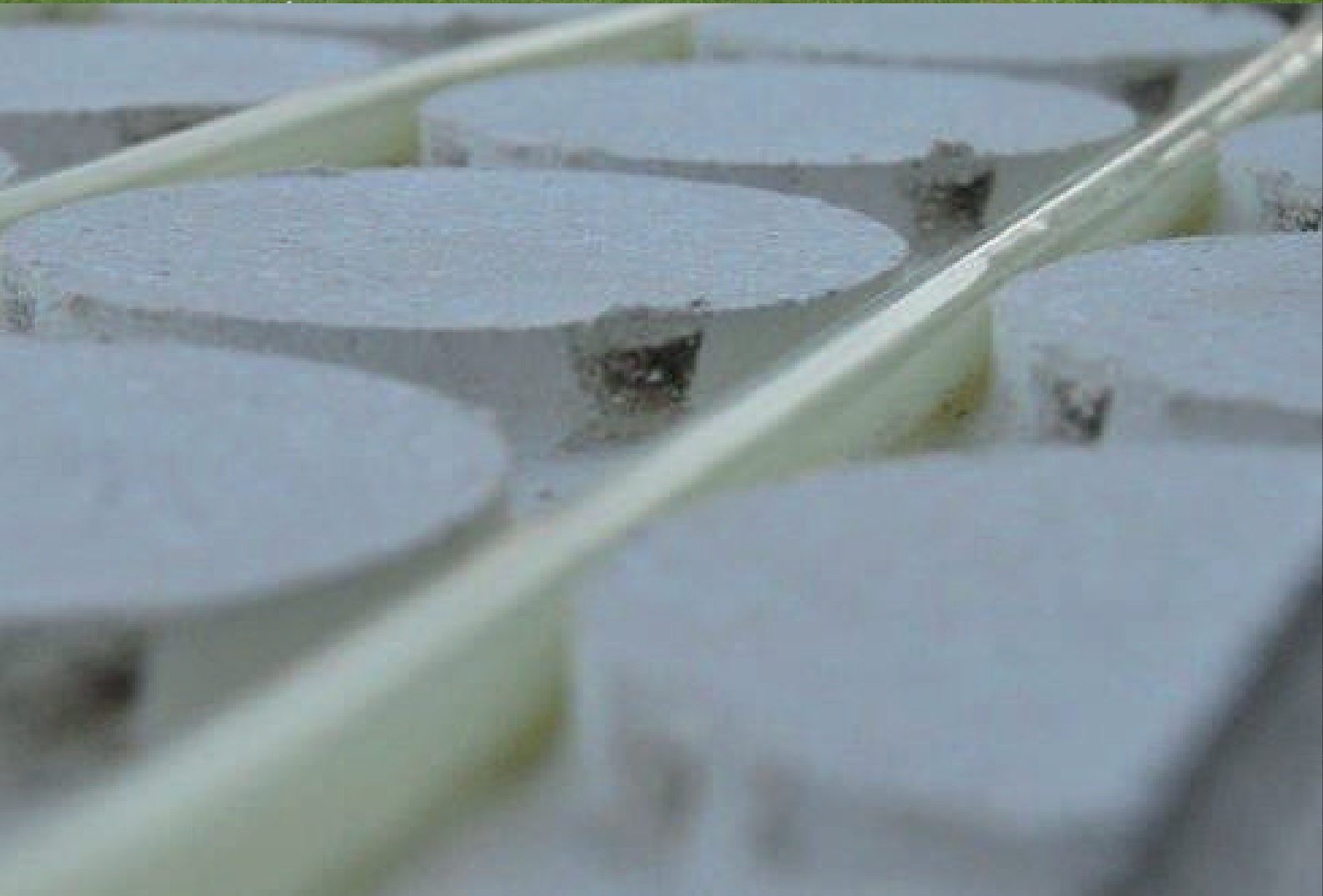

VARMO DRY

LOW THICKNESS PANEL

VARMO DRY

LOW THICKNESS DRY RADIANT SYSTEM



VARMO DRY is an innovative system that allows underfloor heating to be created in just 3 cm (finished system with flooring). This solution is defined as “dry” because the concrete screed does not have to be made. The thickness of the floor must be added to the FERMACELL panels, to be fixed on top, with a total thickness that depends on the type of finish adopted and which is usually a maximum of three centimeters overall. Traces were obtained on the panels to insert a small diameter pipe (11.6 or 12 mm), which guarantees a low thermal inertia. A warning before installing VARMO DRY is to have a smooth support surface. In case of renovations of existing homes it is recommended to fix the panels directly on the existing flooring.

CODE	Ø	✱	◇	◻
PI00VDW18GFB0H	1200x600 mm	18 mm	-	-
PI00VDW18GFL0H	1200x600 mm	18 mm	-	-
PI00VDW18GFLBH	1200x600 mm	18 mm	-	-
PI00VDW18GFPCH	1200x600 mm	18 mm	-	-
PI00VDW18GFBPH	600x298 mm	18 mm	-	-

*until stocks are exhausted

ADVANTAGES

- Reduced dimensions: In just 3 centimeters, finished systems can be created (flooring included).
- Can be laid on pre-existing floors
- Quick and easy to lay: it is not necessary to cast concrete (screed) and wait for it to mature
- Ideal for renovations
- Low thermal inertia
- No limitations on the choice of floor coverings

COMPONENTS AND MATERIALS

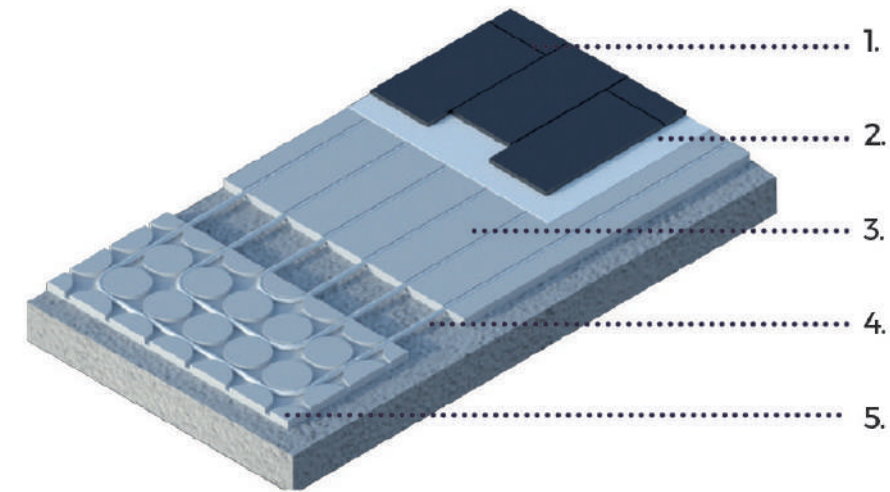

LEGEND	MATERIALS
1.	flooring
2.	mat (optional)
3.	VARMO DRY linear panel (H 18mm)
4.	pipe Ø11.6- pipe Ø 12 mm
5.	VARMO DRY panel for bends (H 18mm)

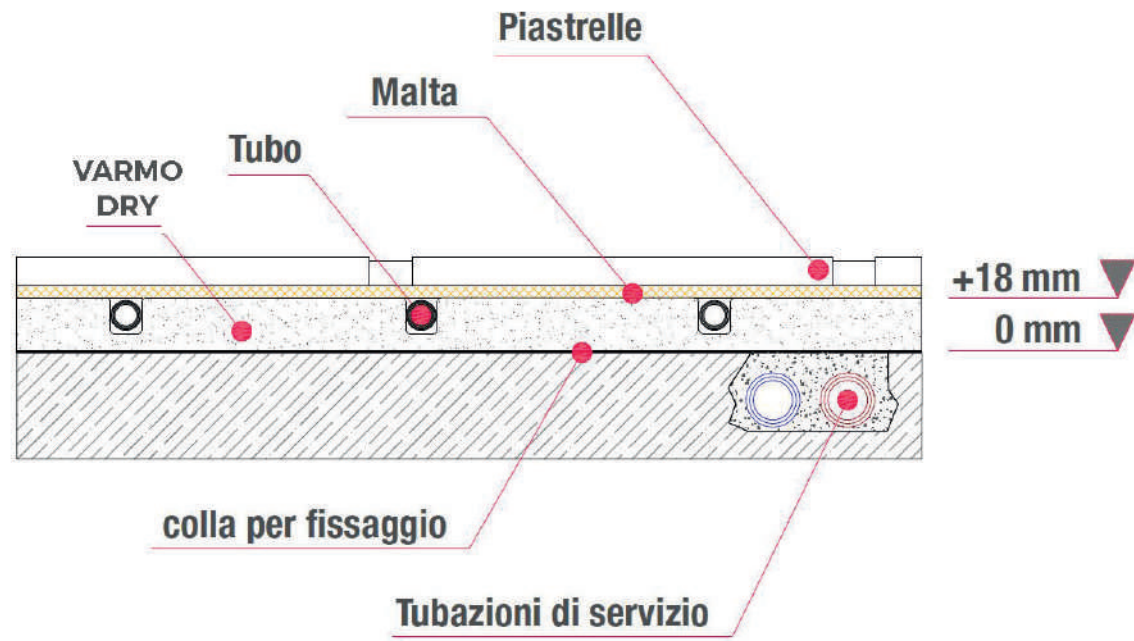

TECHNICAL INFORMATION

FEATURES	PI00VDW18GFBPH	PI00VDW18GFB0H	PI00VDW18GFL0H	PI00VDW18GFLBH	PI00VDW18GFPCH (until stocks last)
Total height (mm)	18				
Pipes (mm)	11,6 - 12				
Total panel size (mm)	600x298	1.200x600			
Surface weight kg / m ²	21				
Thermal conductivity EN 12 667 W/mK	0.32				
Thermal capacity / specific heat kJ / KgK	1.1				
Nominal dry density (kg / m ³)	150±50				
Minimum installation pitch (mm)	100				
Fire resistant EN 13501-1	A2, s1-d0				
Resistance to vapor diffusion (μ)	13				
Expansion / bending due to relative humidity variation of 30% (at 20 ° C) mm / m	0.25				
Humidity compensation with relative humidity 65% and temperature 20 ° C %	1.3				
Ph	78				
Brinell hardness n / m ²	30				

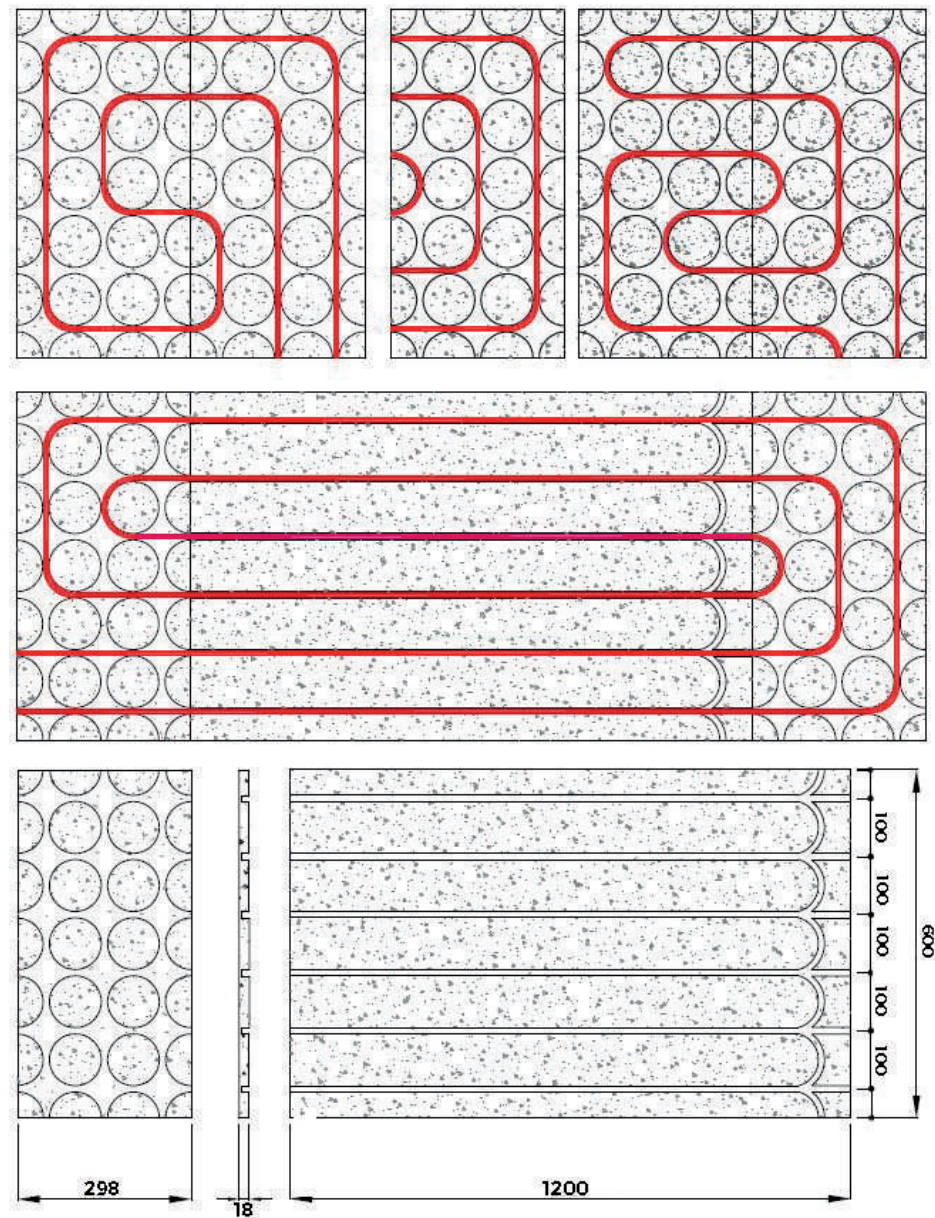

VARMO DRY panels are made in different versions: the largest is used where the pipe has a straight path, the smallest is positioned where the pipe must be blended. The installation distance is constant at 10 cm.

To avoid excessive pressure drops, it is recommended that the length of the circuits does not exceed 60 m (equivalent to 6.5 m²).

Since the flow rate for each panel (120 ÷ 140 l / h max) is limited, it is possible to use a split connection fitting in order to reduce the size of the manifold.

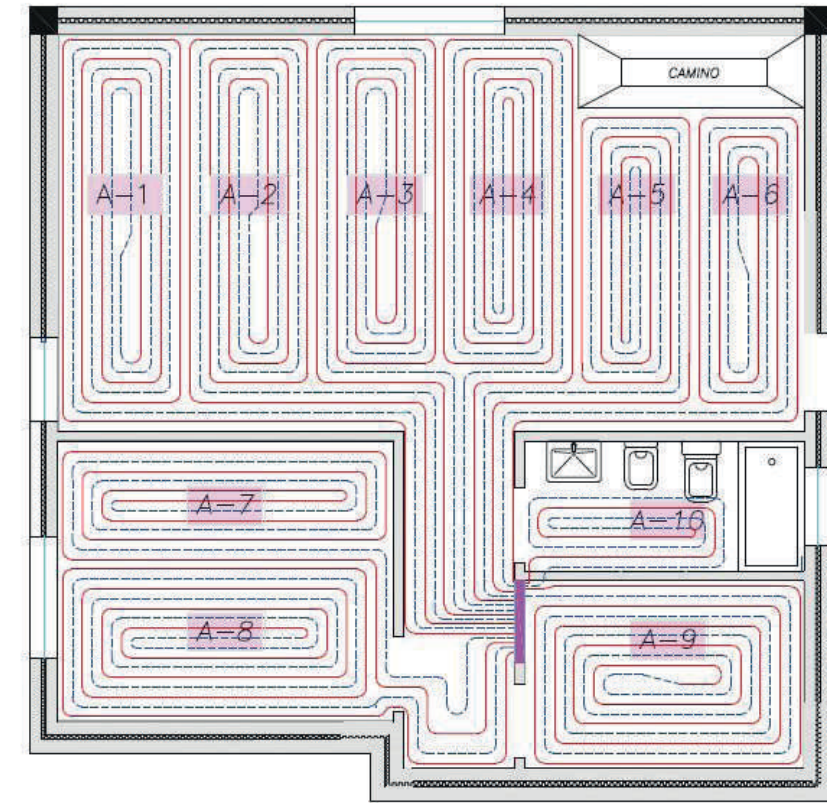

REFERENCE	MT
A1	64 Mt
A2	59 Mt
A3	54 Mt
A4	58 Mt
A5	42 Mt
A6	45 Mt
A7	48 Mt
A8	58 Mt
A9	56 Mt
A10	27 Mt

COMPONENTS		COMPONENTS	
	Mixing unit	P. 127	
	Manifolds	P. 155	
	Pipes	P. 103	
	Perimeter edging	P. 107	
	Skim mortar	P. 105	
	Adhesive for panel	P. 105	



PIPES AND ACCESSORIES FOR RADIANT PANELS



TB00.50 LINE TB00.20 LINE

PE-RT AND PE-X PIPES FOR RADIANT FLOOR HEAT SYSTEM

General Fittings proposes 3 types of pipes for radiant floor heat system: PE-RT, PE-X/Al/PE-X, PERT/Al/PE-RT.

PE-RT PIPE

The PE-RT plastic pipe is extremely solid and resistant and consists of a 5-layer structure with an oxygen barrier. The EVOH layer provides a good barrier to oxygen and completely protects the structure from external influences. The structure and composition ensures good thermal stability at high temperatures up to 90 °C.

TB00.50 PE-RT



CODE	Ø	✱	👁
TB0050H121420A	12	1.4	200 m
TB0050H121460A	12	1.4	600 m
TB0050H162020A	16	2.0	200 m
TB0050H162060A	16	2.0	600 m
TB0050H172020A	17	2.0	200 m
TB0050H172060A	17	2.0	600 m
TB0050H202020A	20	2.0	200 m
TB0050H202060A	20	2.0	600 m

TB00.20 PE-RT II/AL/PE-RT II



CODE	Ø	✱	👁
TB0020H111520S	11.6	1.5	200 m
TB0020H111560S	11.6	1.5	500m

PE-Xb/Al/PE-Xb PIPE

The multilayer pipe of the TB00.20 series is composed of a 5-layer structure: the butt-welded aluminum layer is enclosed between two layers of polyethylene. The pipes are resistant to corrosion and have characteristics of lightness, hygiene and a very smooth contact surface with the transported fluid.

The presence of aluminum makes it possible to shape the pipe with extreme simplicity and prevent the passage of oxygen inside the duct

TB00.20 PE-XB/AL/PE-XB



CODE	Ø	✱	👁
TB0020H162000V	16	2.0	100 m
TB0020H162020V	16	2.0	200 m
TB0020H162050V	16	2.0	500 m

ADVANTAGES

- High flexibility: easy to install
- Lightness
- EVOH barrier
- Corrosion resistance

AP00.00 ADHESIVE FOR PANEL



CODE	Ø	i	◇	□
AP0000H750000H	0.30 lt	VARMO DRY	-	-

Used to attach panels to existing flooring or a planar slab. One package per 4 m².

AD00.00 ADDITIVE



CODE	Ø	◇	□
AD0000H025000H	25 lt	-	-

A formaldehyde- and polycarboxylate ether chlorides (PCEs)-free additive with a cloudy amber color for making high-performance, workable cement mixtures. It is perfectly soluble in mixing water, harmless to reinforcing bars. It complies with the UNI EN 934-2:2012 standard. Dosage: 1.2% on cement weight. Shelf life: 12 months d.o.p.

BV00.00 VAPOUR BARRIER



CODE	Ø	◇	□
BV0000H100000H	100 m ²	-	-

PE-LD protection layer made of high-density, waterproof polyethylene, with high resistance to chemical and physical aggression of cementitious artifacts. 150 µm thickness. Suitable for insulating against rising damp.

CF00.00 PIPE CLIP FOR BOSSED

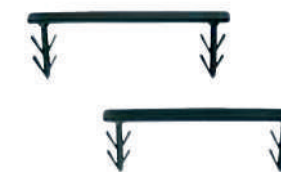

CODE	i	◇	□
CF0000HBUGNATO	VARMO FORM-VARMO WELD	100	-

Linear molded polyethylene clips for clamping pipe between ashlar and ashlar near sharp bends for fixing mesh.

AR00.00 SKIM MORTAR



CODE	Ø	i	◇	□
AR0000H025000H	25 Kg	VARMO DRY	-	-

Used for topping up tracks and making the top surface planar. Use 4kg/m² with linear panels. Usage 7kg/m² with embossed panels. Usage 5kg/m² on average.

BD00.00 PIPE FIXING BAR



CODE	Ø	◇	□
BD0000H162000H	1 m	-	-

PVC pipe guide with teeth for anchoring to the panel. Diameter of pipe accommodated from 16 to 20. Laying pitch 5 cm. Bar length 1 m, height 3 cm.

CF00.00 PIPE CLIP

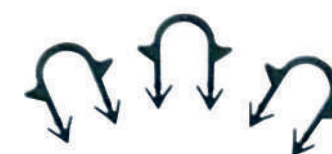

CODE	i	◇	□
CF0000HPIANO00H	VARMO FLAT-VARMO ROLL	30	-

Linear molded polyethylene clips for clamping pipe between ashlar and ashlar near sharp bends for fixing mesh.

CU00.00 ELBOW



CODE	Ø	i	◇	□
CU0000H170000H	17	conventional panels	50	-
CU0000H200000H	20	conventional panels	50	-

FP00.00 PERIMETER EDGING



CODE	Ø				
------	---	--	--	--	--

FP0000H150060H	150 mm	60 m	conventional panels	-	-
FP0000H800020H	80 mm	20 m	dry panels	-	-

PE perimeter strip made of closed-cell polyethylene, waterproof, mold-resistant and with high resistance to chemical aggression and alkaline reactions of cementitious products. With adhesive band for ground fixing.

GD00.00 EXPANSION JOINT



CODE	Ø		
------	---	--	--

GD0000H200000H	2 m	-	120
----------------	-----	---	-----

PE expansion joint made of closed-cell polyethylene, waterproof, mold-resistant, and with high resistance to chemical attack and alkaline reactions of cementitious products. With adhesive band for ground fixing.

RS00.00 STABILIZER NETWORK

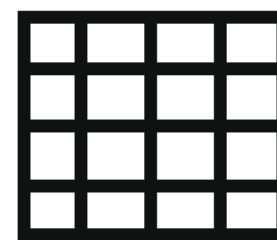

CODE	Ø			
------	---	--	--	--

RS0000H405050H	1 x 50 m	50 m	-	-
----------------	----------	------	---	---

PP mesh, with high mechanical and chemical resistance of cementitious artifacts. With 45x40 mm mesh, height 1 m. To be used embedded in the screed as a structural mesh.

SA00.00 SANITIZER FOR THERMAL CIRCUITS



CODE	Ø		
------	---	--	--

SA0000H010000H	1 kg	-	-
----------------	------	---	---

MC00.00 ANTI-IMPACT MAT



CODE	Ø		
------	---	--	--

MC0000H000000H	75 m2	-	-
----------------	-------	---	---

PC00.00 CLIP FIXING DEVICE



CODE		
------	--	--

PC0000H000000H	-	-
----------------	---	---

SB00.00 PIPE UNWINDER FOR RADIANT SYSTEMS

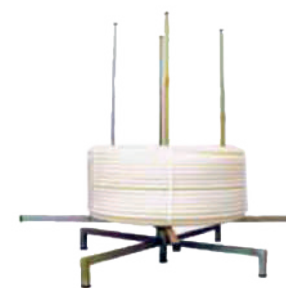

CODE		
------	--	--

SB0000H000000H	-	-
----------------	---	---

TP00.00 ELECTRIC KNIFE



CODE		
------	--	--

TP0000H000000H	-	-
----------------	---	---

TT50.00 ROTELLA WHEEL PIPE CUTTER FROM Ø14 TO Ø26



CODE		
TT5000H142600V	-	-

TT50.00 CESCOIA SHEARS PIPE CUTTER TC 0-42MM



CODE		
TT5000HROCU42V	-	-

AC00.91 BIG BIG PRESS MACHINE - with jaws Ø 16-20-26



CODE			
AC0091HJBAPS3V	16-20-26	-	-

AC00.91 MINI MINI PRESS MACHINE -with jaws Ø 16-20-26



CODE			
AC0091HJBSPM1V	16-20-26	-	-

AC00.80 MINI JAW FOR MINI PRESS MACHINE - TH PROFILE



CODE			
AC0080T16019JV	16	-	-

AC00.80 BIG JAW FOR BIG PRESS MACHINE - TH PROFILE



CODE			
AC0080T16032JV	16	-	-

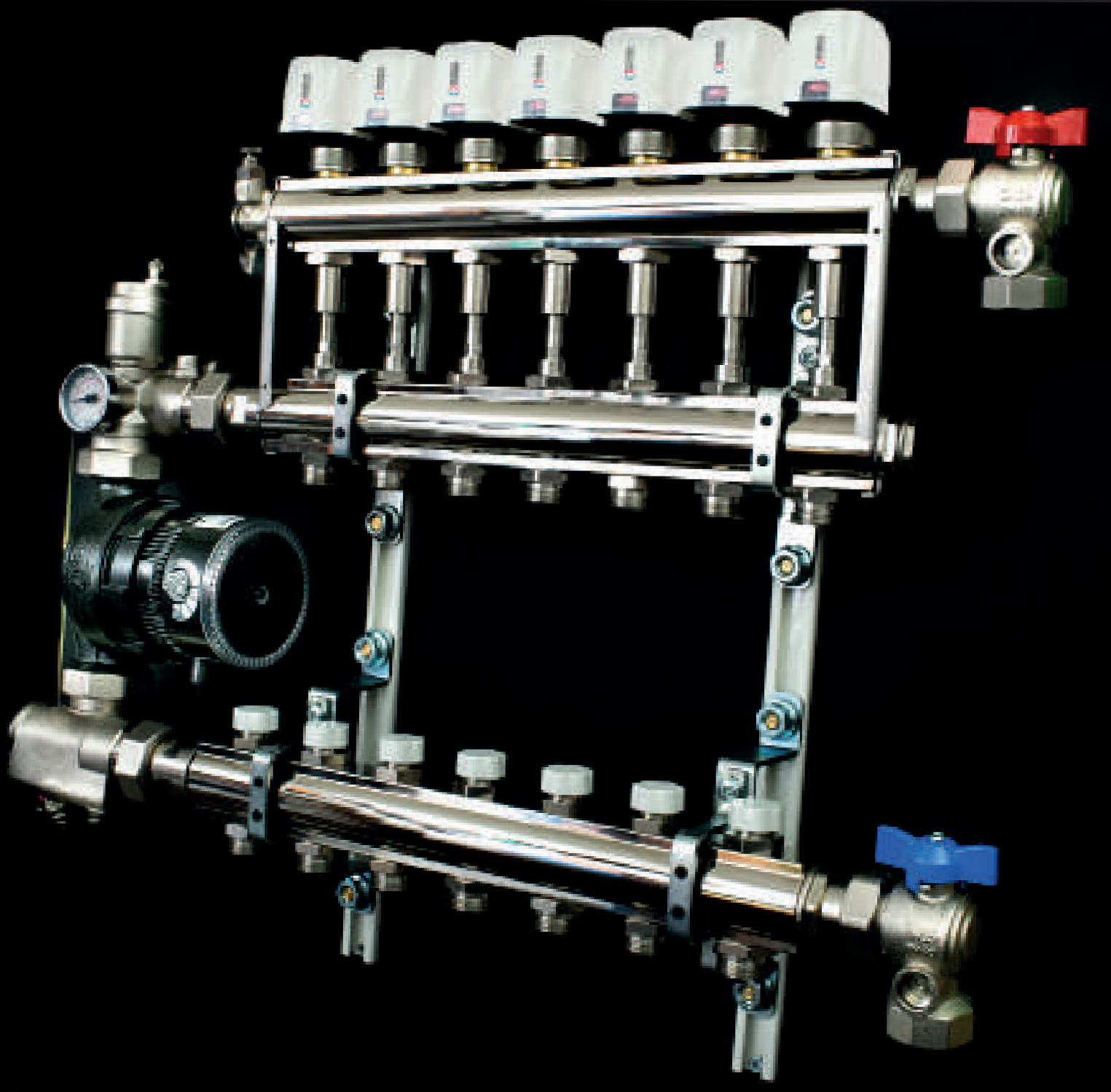

MIXING AND WATER DISTRIBUTION

Tritone |
Fixed point mixing station |
Pump unit |

Stainless steel manifolds |
Line 6500 manifolds |

TRITONE

TRITONE

MIXING UNIT

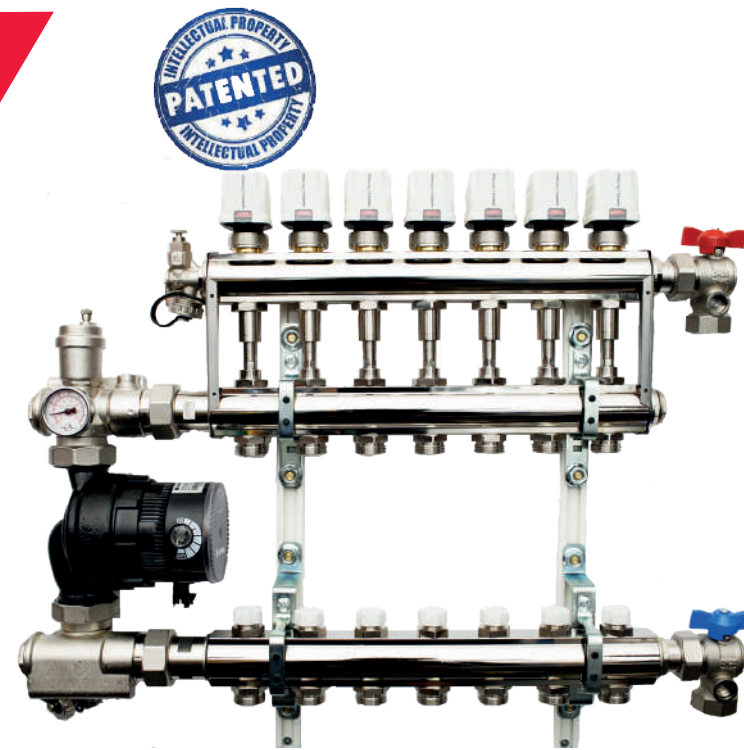

TRITONE is an all in one compact injection mixing control unit for the distribution of water at high and low temperature, for heating and cooling system. Compatible with all high and low temperature generators. In order to give a real answer to the market requirements, TRITONE has been developed and created by GENERAL FITTINGS to ease the job of architects, engineers and installers in the realization of the systems. TRITONE is a mixing control unit with constant flow and adjustable temperature for each single circuit independently

ADVANTAGES

- Patented
- Ideal for all types of systems and heat generators
- It is possible to manage different temperatures in each room
- Unique manifold for low as well as for high temperature heating systems.
- Freedom of floor covering selection (even after installation)
- Compatible with integrated domotic systems
- Silent
- Adjustable circuit temperature + constant flow rate = greater comfort
- Slower room cooling
- Less starts of the heat generator = greater comfort
- It works both with heating and cooling systems



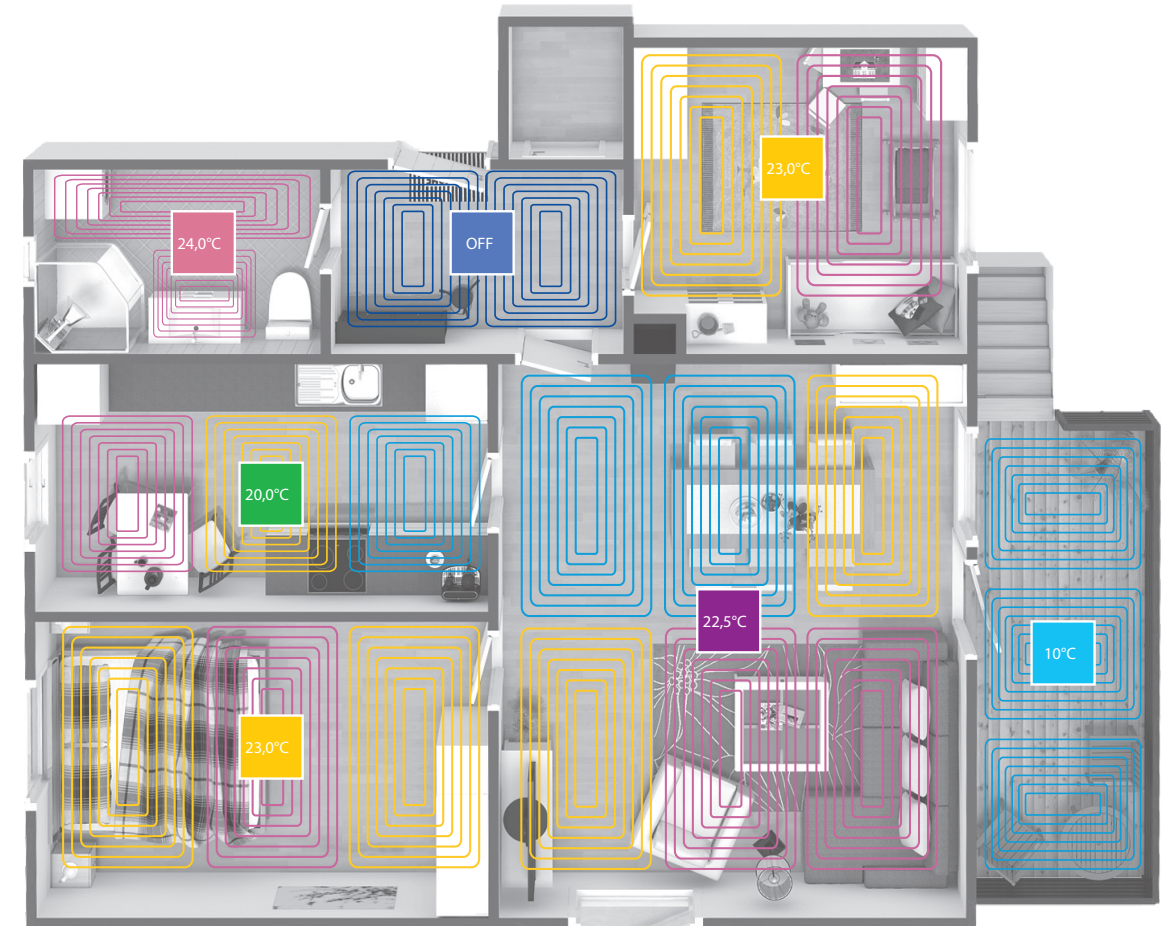

TEMPERATURES IN DIFFERENT ENVIRONMENTS



Thanks to its peculiarities, Tritone mixing unit allows to adjust temperatures in various environments easily and immediately, thus overcoming the distinction between "disadvantaged" and "favored" environments.

- The temperature of the liquid in the various environments can be adjusted in a few simple steps.
- The liquid flow rate supplied by the heat generator is constant in all rooms.

FIELDS OF APPLICATION

	APPLICATIONS	T. MAX	PRESS.MAX
	low temperature heating (floor)	+80°C	7 bar
	low temperature heating (wall)	+80°C	7 bar
	low temperature heating (ceiling)	+80°C	7 bar
	radiators	+80°C	7 bar
	cooling	+80°C	7 bar

GENERATORS TO CONNECT TO TRITONE TO

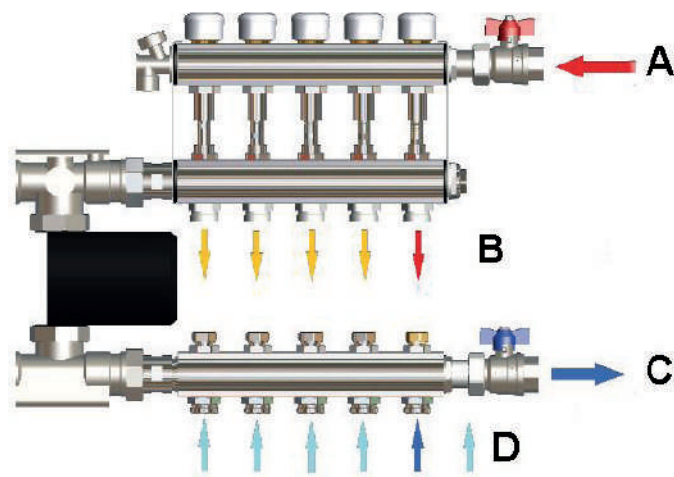

LEGEND	DESCRIPTION
A	ENTRY FLOW FROM HEAT GENERATOR (PRIMARY)
B	RETURN TO HEAT GENERATOR (PRIMARY)
C	ENTRY FLOW TO LOOPS AND HEATED TOWEL RACKS (SECONDARY)
D	RETURN FLOW FROM LOOPS AND HEATED TOWEL RACKS (SECONDARY)

The TRITONE injection control unit can be fed by any heat generator which produces low temperature water (30 °C-45 °C) or high temperature water, to a maximum of 80 °C (suggested temperature: max 70 °C).

The most common types of hot water generators are:

- Sealed chamber boiler
- Condensation boiler
- Biomass/fireplace boilers
- Heat pumps
- Geo-heat exchangers
- All heat generators that guarantee a constant flow rate to the manifold

TRITONE is equipped with an extremely silent latest generation pump. This allows the mixing control unit to be installed in any room, even those more sensitive to heat (for example bedrooms). The noise level is 22.8 dB.

HYDRAULIC DIAGRAM

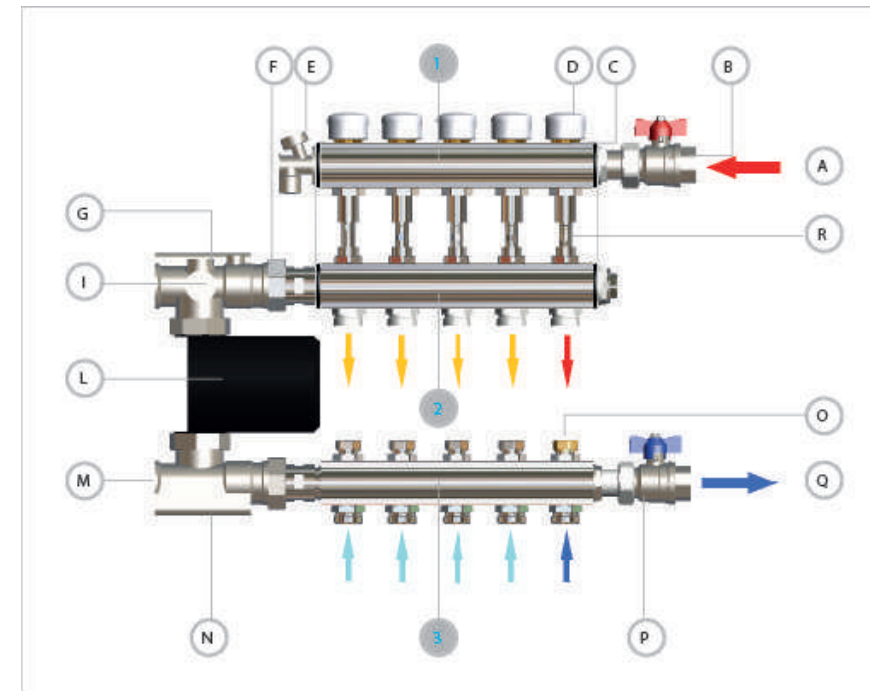

LEGEND	ELEMENT	LEGEND	ELEMENT
A	Hot water from generator	I	Thermometer
B	Entry flow primary circuit shut-off valve	L	Pump
C	Mechanical actuator	M	Pump connection
D	Protective cap	N	Exhaust valve
E	Filling valve / venting valve	O	Lockshield
F	Check valve	P	Return primary circuit shutoff valve
G	Pump connection	Q	Return water to generator
1-2-3	Bar manifolds	R	Injector

FUNCTIONING

The liquid (A) comes from the heat generator and enters the TRITONE manifold (1) through the ball valve (B).
 The liquid is thrust by the pump of the heat generator into the injectors (R) that send it to the loops of the secondary circuits or to the high temperature utilities.
 The return liquid of the loops of the secondary circuit enters the manifold (3):

- if mixed it is partially recalled by the pump of the control unit (L)
- if coming from the high temperature loops (heated towel rack or radiators), it is recalled by the pump of the heat generator (Q) passing through the valve (P).

The high temperature return circuit must be positioned in the closest connection to the return in the heat generator (valve P). The low temperature return circuit transits from the valve unit (M) recalled by the pump (L), then from the unit (G) from the check valve (F) entering the manifold (2) where it mixes with the high temperature liquid through the injectors (R) coming from the heat generator (A) again entering in circulation.
 The return manifold (3) can be supplied with mechanical memory lockshield (O) which is always fully open, or with flow meters (on demand) also in the fully open maximum flow position.
 The control unit is completed by the filler valve (E) upon which a venting valve and an exhaust valve (N) are fitted.
 The circulator complies with the ERP regulations on energy saving.

CONFIGURATION

SUPPLIED INSTRUMENTS	
1" and 1"1/4 brass bar	CW603N
M30x1.5 connection spindle	CW617N
Shutoff valves with 3/4" connection	CW617N
Venting valve	CW617N
2 to 13 way shunt	Eurokono
Injectors	CW617N
PUMP	
Pump	variable flow rate
energy-saving (ERP)	
Power supply	230Vac/50Hz
Pump connections	1"1/2 centre distance 130mm
Protective rating	IP44
MISCELLANEOUS	
Handle	ABS
Thermometer	0...80°C

CONFIGURATION

OPTIONAL INSTRUMENTS	
Euroconus Adapters	CW617N
Return flow meter	1 - 4 lt
1" fitting	CW617N
1" 1/4 fitting	CW617N
DRAWER	
Recessed drawer	Painted iron, RAL 9010
Support brackets	Painted iron, RAL 9010
Screws and bolts	Galvanised iron
MISCELLANEOUS	
Circuit thermometers	4.8 x 1.2 cm
Electrothermal head	230Vac with 4 wires
Room thermostat	ON/OFF, wireless chronothermostat-thermostat
Control unit	8 relay 230Vac module
Antenna	Active antenna

TEMPERATURE ADJUSTMENT FOR SECONDARY LOOPS LIQUID

TRITONE was designed so that each injector corresponds to a secondary distribution loop. Each injector can be tuned independently from the others.

The adjustment of the liquid temperature (secondary balancing) must be carried out after the electrical connection of electrotemic heads and thermostats (or equivalent).

TEMPERATURE OF HEAT GENERATOR LIQUID

We propose two cases:

1. Environments with high temperature device (for example heated towel rack or radiator) and low temperature (for example radiant floor system).

The liquid temperature of the primary circuit must be the same as the device which requires high temperatures.

2. Environments with only low temperature device (for example radiating panel heating).

The temperature of the liquid of the high temperature flow (primary) must be at least 10° higher than the highest temperature requested by the system flow (secondary), anyhow never lower than 40-45 °C. We recommend 50 °C.

According to standard UNI EN 1264-4:2009 (Water based surface embedded heating and cooling systems), the temperature of the floor should be lower than 29 °C, aside from rare cases in areas closed to the external walls or to windows. ADJUSTMENT OF THE LIQUID TEMPERATURE IN THE LOOP TRITONE injectors are tuned with the default setted points. The liquid temperature of the loops therefore varies depending on the liquid temperature of the heat generator.

The liquid temperature of the loops connected to TRITONE can be modified at any time in a simply and quick way.

The temperature of each loop can be increased or decreased by simply adjusting the injectors according to the project or environment confort.

After calibrating the injector, the appropriate controls must be carried out. The temperature variation of the loop can be checked and tuned quickly with contact thermometers pointed on the secondary loops pipes.

OPERATION OF THE TUNING OF SECONDARY LOOPS LIQUID TEMPERATURE

Temperature is controlled by turning the injectors with a simple 11mm spanner.

- Turn the injector clockwise to raise the temperature of the circuit to the maximum temperature set in the heat generator
- Turn the injector anticlockwise to obtain the desired temperature by mixing of the delivery and return liquids.

Use contact thermometers to check the temperature.

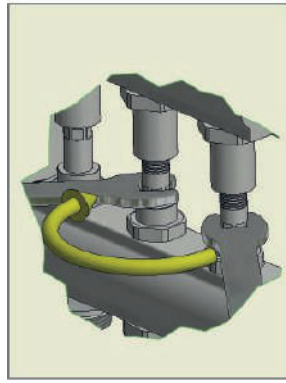

CALCULATION OF THE SYSTEM FLOW RATE

Since TRITONE is a mixing unit with constant flow and adjustable temperature, to calculate the flow rate of the system and verify its correct functionality it is necessary to set up a simple graph in which:

- A. is the point of intersection between the value of the flow temperature from the heat generator (e.g. 50 °C) and that of the overall flow rate of the circuit as per project (e.g. 100l / h)
- B. indicates the average return temperature that can be displayed on the thermometer placed above the circulator (e.g. 20 °C)
- C. is the delivery temperature of the secondary circuit (in example 27.5 °C)
- D. is the consequent flow rate of the secondary circuit that can be calculated from the intersection of the value of C with the AB axis (in example 25l / h)

For example, when the average return temperature is 30 °C, the flow temperature will be 35 °C (point E)

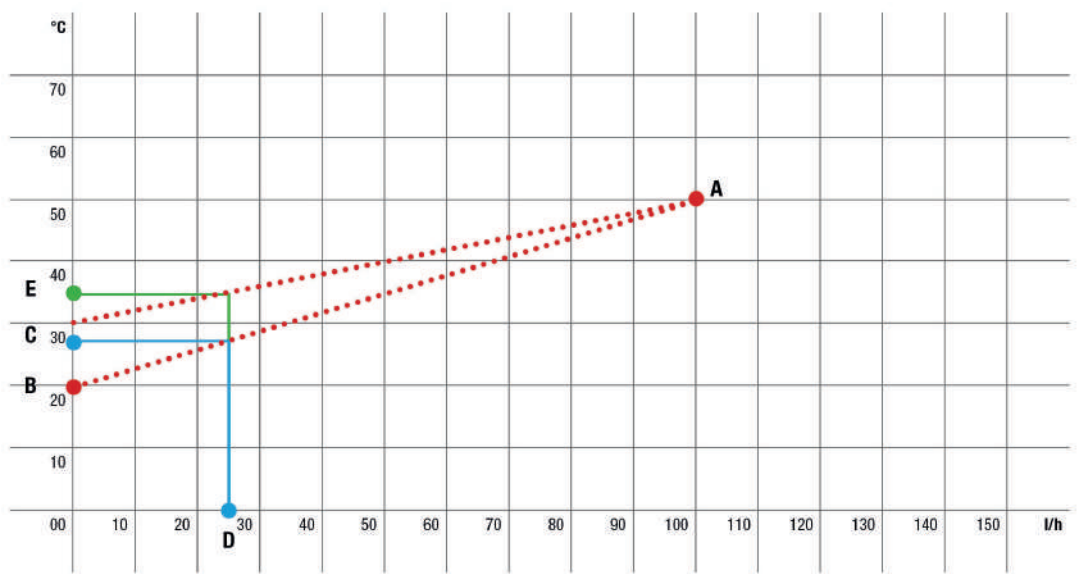

ELECTROTHERMAL HEADS OR ELECTROMECHANICAL ACTUATORS

The electrothermal head is an electromechanical actuator which controls opening and closing (ON/OFF) of TRITONE's mechanical shutter.

General Fittings supplies electrothermal heads with 4-wire 230Vac power supply, with auxiliary control to switch off the pump.

ELECTROTHERMAL HEAD ASSEMBLY

General Fittings heads are fitted on the thermostatic spindles/shutters of the manifolds with a M30x1.5 thread.

The installation procedure is as follows:

- remove the protective cap
- place the thermostatic head on the spindle/shutter
- screw the metal ring nut by hand
- perform the electrical connections as per diagram.

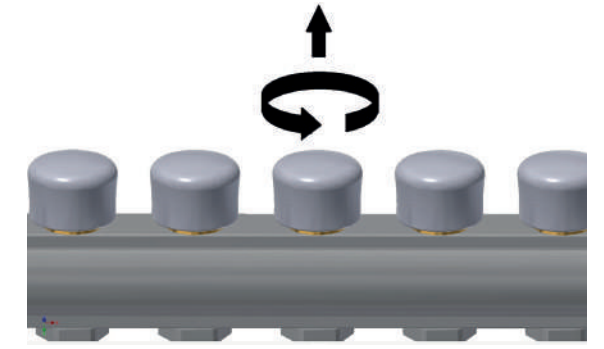

ELECTRICAL CONNECTIONS

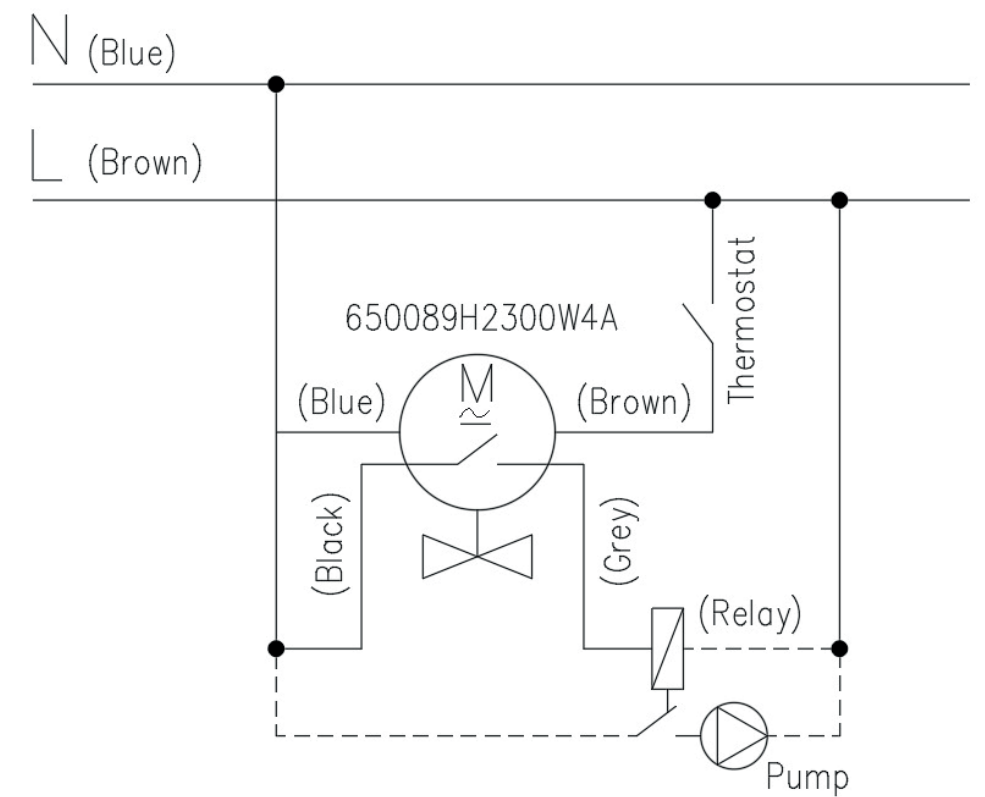

BALANCING THE LOOPS

TRITONE does not require balancing the flow rate of the circuits, as it is a constant flow rate control unit. It is however possible to adjust the temperature of each individual circuit.

Whether TRITONE is supplied with mechanical lockshield memory or with flow meter on the return of the secondary circuit, their adjustments must never be modified without consulting our technical department.

TRITONE is equipped with lockshields or flow meters on demand at the complete opening position

FILLING THE SYSTEM

Filling the system is a delicate operation which must be performed by skilled personnel. It is aimed having the minimum amount of air possible inside the pipes which in certain situations could determine malfunctioning.

1. Close both the entry flow ball valve (B) and the return flow ball valve (P).
2. Connect the liquid flow to the filler valve (E) applied to the manifold (1).
3. Close all the connections (D) of the loop on the manifold (1), except the first closest to the filler valve(E): it is closed by turning the supplied plastic caps mounted on the thermostatic spindles clockwise.
4. Close all the lockshields/flow meters (O) applied to the manifold (3), except the one on the connections left open
5. Open the water flow on the filler valve (E).
6. Open the exhaust valve N on the manifold (3), making sure there is absolutely no air.
7. Close the exhaust valve (N).
8. Close the connection just filled (D) and the respective lockshield (O).
9. Open the connection after the one just closed (D)

TYPE OF CASE AND POSITIONING

TRITONE is supplied in basic configuration coupled to a case (optional), the size of which is indicated below. It can also be used with third-party recessed metal cases, with the size indicated below.

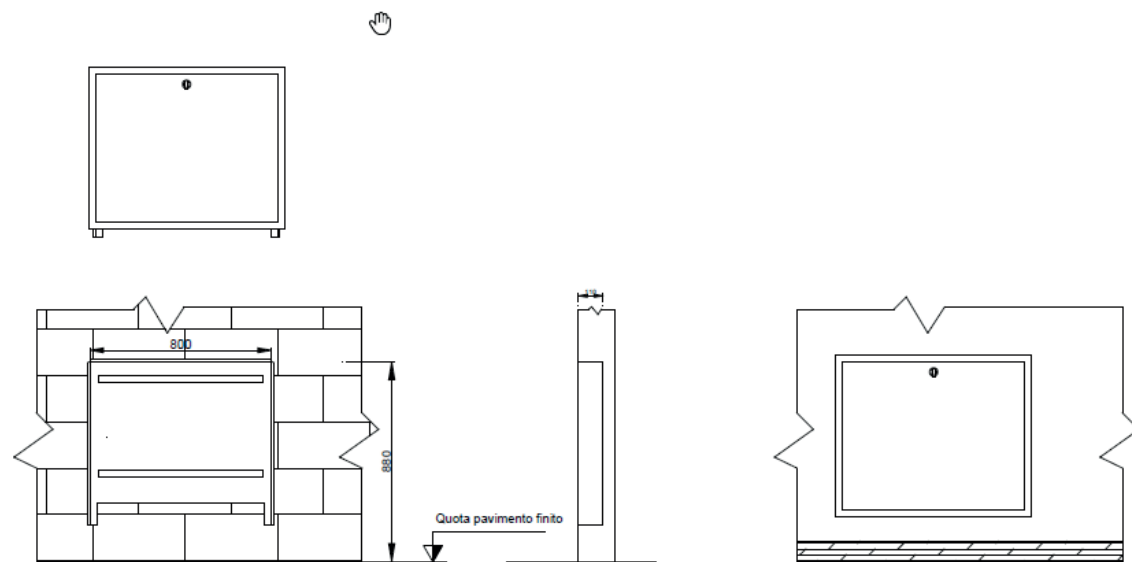

CASE DIMENSIONS

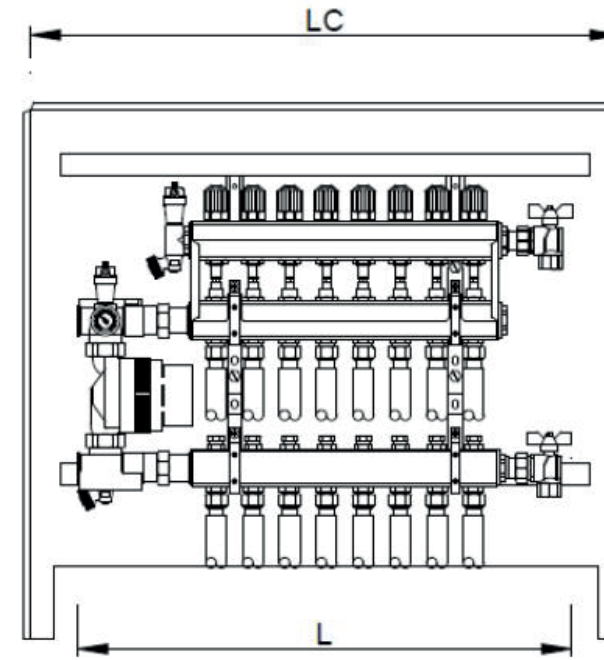

MIXING UNIT	L	LC
2 connections	370 mm	720 x 700 mm
3 connections	420 mm	720 x 700 mm
4 connections	470 mm	720 x 700 mm
5 connections	520 mm	720 x 700 mm
6 connections	570 mm	720 x 700 mm
7 connections	620 mm	720 x 700 mm
8 connections	670 mm	720 x 900 mm
9 connections	720 mm	720 x 900 mm
10 connections	770 mm	720 x 900 mm
11 connections	820 mm	720 x 1000 mm
12 connections	870 mm	720 x 1000 mm
13 connections	920 mm	720 x 1000 mm

CERTIFICATIONS

COUNTRY	CERTIFICATION	COUNTRY	CERTIFICATION

ASSEMBLY

1. Open the box



2. Remove the TRITONE mixing control unit.



3. Install the control unit in the specific case, first releasing it from the top brackets and then from the bottom ones.



4. Connection of entry/return flow primary circuits from heat generator.



ASSEMBLY

5. Connection and tightening of entry/return flow secondary circuit from high temperature and low temperature system.

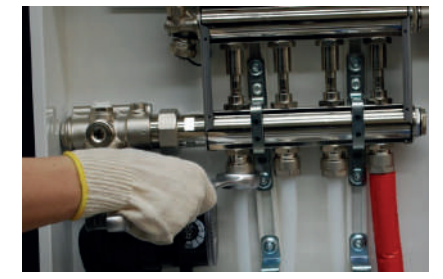

6. Hydraulic connection from which to fill the system.

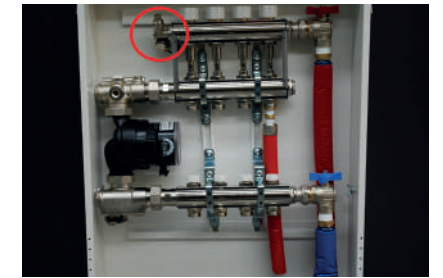

7. Filling the system: close the entry/return valves of the primary circuit (red and blue); open manually the first thermostatic shutter and turn the specific knob anticlockwise.



STEPS 7-10 MUST BE REPEATED FOR AS MANY TRITONE CONFIGURATION CHOSEN CONNECTIONS.

ASSEMBLY

8. Filling the system: close the following shutters by turning the specific knobs clockwise.



9. Filling the system: open the first lockshield by turning the Allen wrench anticlockwise.



10. Filling the system: close the following lockshields by turning the Allen wrench clockwise.

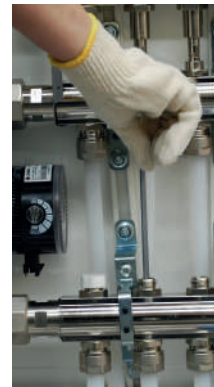

11. Electrical connection.

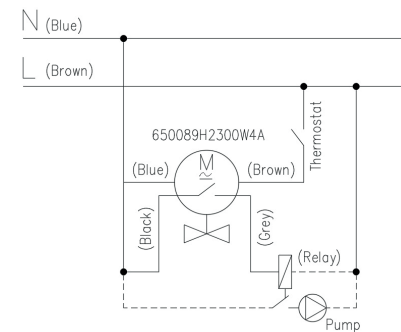

ASSEMBLY

12. Liquid temperature adjustment of secondary circuits with 11 mm spanner.



6500.E9 MIXING CONTROL UNIT WITH MECHANICAL BALANCING SCREWS

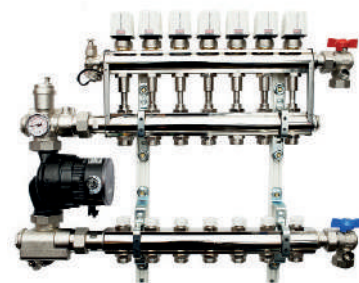

CODE				
6500E9N100502V	2	3/4" EK	1"	- -
6500E9N100503V	3	3/4" EK	1"	- -
6500E9N100504V	4	3/4" EK	1"	- -
6500E9N100505V	5	3/4" EK	1"	- -
6500E9N100506V	6	3/4" EK	1"	- -
6500E9N100507V	7	3/4" EK	1"	- -
6500E9N100508V	8	3/4" EK	1"	- -
6500E9N100509V	9	3/4" EK	1"	- -
6500E9N100510V	10	3/4" EK	1"	- -
6500E9N120511V	11	3/4" EK	1"1/4	- -
6500E9N120512V	12	3/4" EK	1"1/4	- -
6500E9N120513V	13	3/4" EK	1"1/4	- -

6500.89 ELECTROTHERMIC CONTROL



CODE			
650089H2300W4V	230V 4 fili	-	50
650089H2300W2V	230V 2 fili	-	50

Electrothermal control (nc) with 4 wires and 230V; degree of protection IP54; ambient operating temperature 0-50°C; intervention time 3 min

AC00.80.IT MIXING UNIT METAL CABINET-fixing kit included



CODE	ϕ			
AC0080ITR0700V	L=700mm	2-3-4-5-6-7	-	-
AC0080ITR0900V	L=900mm	8-9-10	-	-
AC0080ITR1000V	L=1000mm	11-12-13	-	-

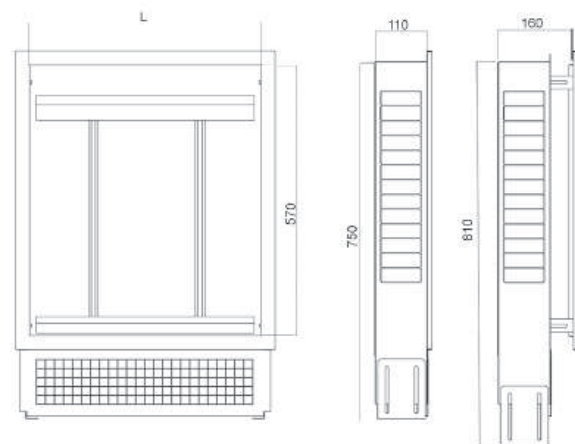

3300.80 NICKEL-PLATED NUT, OLIVE AND INSERT EUROCONE FOR PE-X PIPE



CODE	ϕ			
330080N051214V	3/4"x14	2.0	10	100
330080N051620V	3/4"x16	2.0	10	100
330080N051720V	3/4"x17	2.0	10	100
330080N052020V	3/4"x20	2.0	10	100

5S00.15.N NICKEL-PLATED STRAIGHT FITTING WITH LOOSE NUT AND EUROCONE



CODE	ϕ			
5S0015N051620V	3/4" EKx16	2.0	10	100
5S0015N051820V	3/4" EKx18	2.0	10	100
5S0015N052020V	3/4" EKx20	2.0	10	80
5S0015N052022V	3/4" EKx20	2.25	10	80

6500.H8 SPLITTER



CODE	ϕ		
6500H8N050000V	3/4"	-	50

5700.80 STANDARD NICKEL-PLATED NUT, OLIVE AND INSERT EUROCONE FOR MULTILAYER PIPE



CODE	ϕ			
570080N051620V	3/4"x16	2.0	10	100

RSEI.TR THERMOSTAT DISPLAY VIA RADIO 868 150MHZ d(ON/OFF)



CODE
RSEITRD02B02AV 85x85x23,6 mm - -

RSEI.DC THERMOSTAT DISPLAY VIA RADIO 868 150MHZ d(ON/OFF)



CODE
RSEIDCW01B01AV 87x133x32 mm - -

6500.35.SO THERMOMETER WITH CONTACT PROBE



CODE
650035HSOTERMV -50°C ÷ +130°C - -

AC00.95 LOWARA PUMP ECOCIRC BASIC 25-4/130



CODE
AC0095L0254130 1"1/2 - -

RSEI.DA FSL REPEATER WITH ACTIVE ANTENNA 868 MHZ



CODE
RSEIDA041101AV 85x85x31 mm - -

RSEI.DL MODULE 8 RELAY AND 230V PUMP



CODE
RSEIDL841M1AV 100x245x60 mm - -

6500.35.SI SAFETY THERMOMETER



CODE
650035HSITERMV - - -

6500.35.AD STICKER THERMOMETER



CODE
650035HADTERMV +32°C ÷ +42°C - -

Fixed point thermostatic regulation mixing and distribution unit

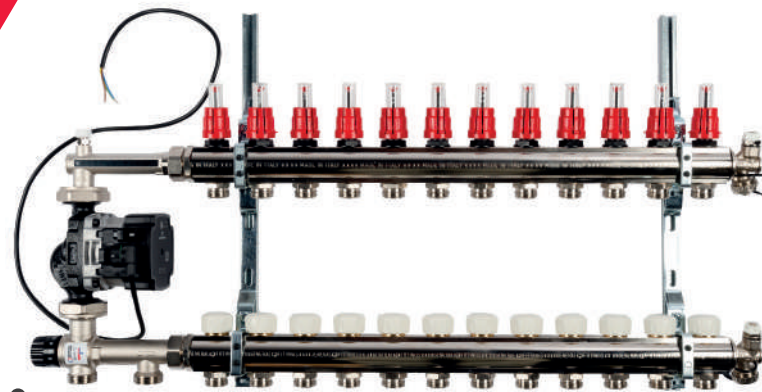

Pre-assembled pump group for fixed point regulation and circulation of mixed fluid. It allows the circulation of the thermal fluid, coming from the primary circuit, by keeping the temperature at a preset value (fixed point) through the help of a mixing valve with thermostatic element.



It is used in heating systems in general and radiant panel systems.

The group is composed of a pump, thermostatic mixing valve, flow LCD thermometers, manual air vent, fittings for secondary distribution manifolds. The group can be installed with the secondary distribution manifolds on the right or the left.

ADVANTAGES

- Reversibility: thanks to the presence of a thermometer also on the rear side, the group can be easily inverted from right to left by fully reversing it.
- Flexibility of installation. The group can be installed on wall, in box or recessed.
- Monobloc structure. The thermostatic mixing valve and the instrument holder fitting, equipped with air vent and thermometers, are designed as monobloc structure. The installation is therefore immediate and points of possible leakage are reduced to a minimum.
- Anti-tamper device. The device, placed within the mixing valve knob, avoids undesired variations of the setting.
- Fast fittings. The provided fittings are equipped with O-Ring and flat gasket to make the installation faster, avoiding the use of other sealing systems like hemp or teflon tapes.
- Instrument holder fitting. Equipped with manual air vent, double LCD thermometer (on front and rear side) to check the temperature of the mixed water supplied to the system.
- Compact installation: the 75 mm centre distance of the primary side, the 211 mm centre distance to the secondary manifold and the 130 mm pump make the installation very compact.

FIELDS OF APPLICATION

	APPLICATIONS	T. MAX	PRESS.MAX
	low temperature heating (floor)	5-90°C	10 bar
	low temperature heating (wall)	5-90°C	10 bar
	low temperature heating (ceiling)	5-90°C	10 bar

PERFORMANCE

PERFORMANCE	
Working temperature range	5-90°C
Maximum working pressure	10 bar
Male threaded connections	ISO 228-1
Centre distance on the primary manifold	75 mm
Connection centre distance to secondary manifold	211 mm
Pump Grundfos UPM3 AUTO 25-70 130	Grundfos UPM3 AUTO 25-70 130
Suitable fluids	water, glycol solutions (max 30%)
Temperature adjustment range	20-55°C
Accuracy	±2 °C
Factory setting	40°C
LCD thermometer scale	24-48°C
Flow coefficient of the mixing valve only	3,5 Kv

MATERIALS

MATERIALS	
Instrument holder fitting	brass EN 12165 CW617N
FITTINGS FOR SECONDARY MANIFOLD	
Body	brass EN 12164 CW617N
Gasket	EPDM
Thermometers	liquid crystals (LCD)
THERMOSTATIC MIXING VALVE	
Body	brass EN 12165 CW617N
Gaskets	EPDM
Headwork	brass EN 12164 CW617N
Spring	stainless steel AISI 302
Thermostatic sensor	wax
Knob	ABS
PUMP	
Body	cast iron
Electric supply	230 V-50/60 Hz
Protection class	Grundfos UPM3: IP 44
Centre distance	130 mm
Connections	G 1 1/2 M (ISO 228-1)
Gaskets	EPDM

INSTALLATION

The mounting options of the group are:

- Wall installation
- Recessed installation
- Box installation

The group can be directly connected to a generator if the latter is not equipped with a pump. Instead, if the generator is equipped with a pump, an hydraulic separator should be placed between the generator and the group, in order to avoid mutual influences between the pumps. The group can be Fixed point mixing station installed downstream of an inertial water storage, which performs the function of an hydraulic separator.

INSTALLATION:
GENERAL
INFORMATION

Assembling and disassembling is to be performed with system cold and without pressure. Accessibility: do not obstruct the access and visibility to the device in order to allow check and maintenance operations to the device or other components.

GROUP POSITION

The group can be installed in one of the ways shown in the picture, with the pump rotation axis always horizontal.

12 o'clock position: suggested.

3 o'clock position: allowed only if the secondary manifold (directly connected to the group) is not equipped with flow meters or it is placed in remote position (only system flow and return pipes are directly connected to the group).

6 o'clock position: allowed but the manual air vent cannot be used anymore since it is placed upside down.

9 o'clock position: see 3 o'clock.

In any case, suitable brackets should be used to fix the group

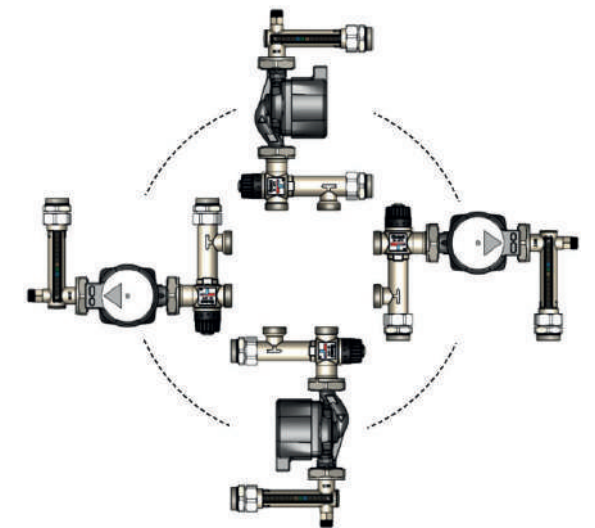

COMPONENTS

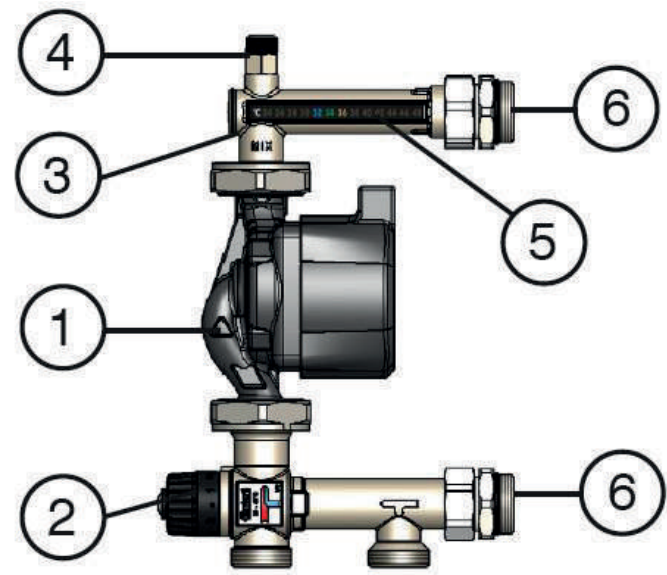

COMPONENTS	
1	Pump
2	Thermostatic mixing valve
3	Instrument holder fitting
4	Manual air vent
5	LCD thermometer
6	Fittings for secondary manifold

GROUP REVERSIBILITY

The nuts are supplied loosened to facilitate the pump rotation on the installation field. Fully screw the nuts before installing the group. The group can be immediately connected to a secondary distribution manifold on its right or left side. To do this, no specific operation is requested. Thanks to the presence of a LCD thermometer also on the rear part, the group can be fully and quickly overturned to screw a distribution manifold on its left side. Fully screw the nuts before proceeding with the installation.

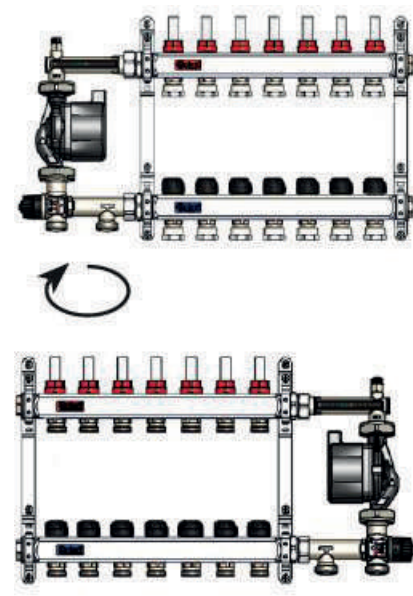

Connection to the secondary manifold.

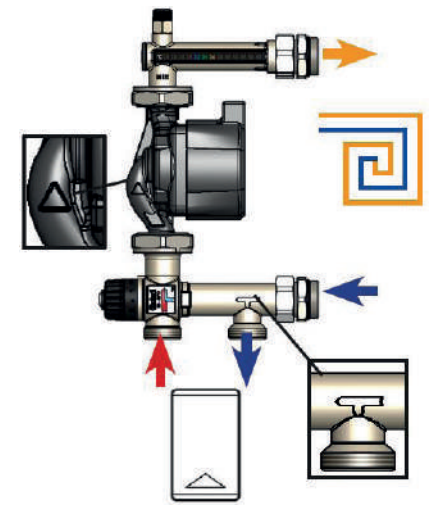

The fittings for the secondary manifold are equipped with O-Ring.

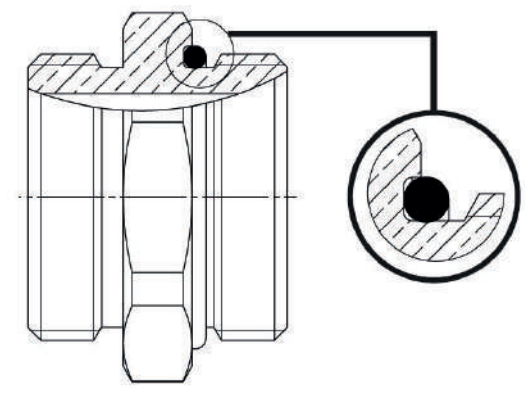

Screw the fittings to the secondary manifold using the threaded part with O-Ring.

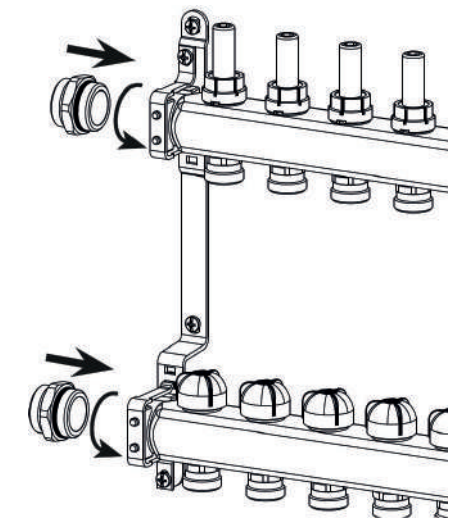

ADJUSTMENT OF THE THERMOSTATIC MIXING VALVE

Screw the other side of the fittings to the regulating group, using the running nuts with flat gasket supplied in the package

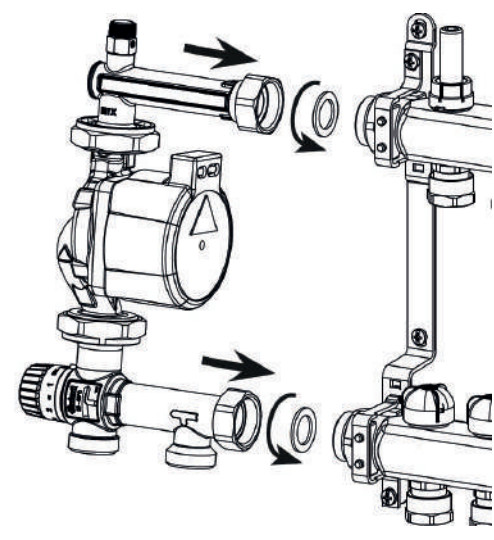

The thermostatic mixing valve keeps constant the temperature of the water supplied to the system. The fixed point regulation is achieved through a thermostatic sensor which moves thanks to the expansion of the wax inside of it. The sensor integrated within the valve is more precise and reliable than the thermostatic valves with external capillary

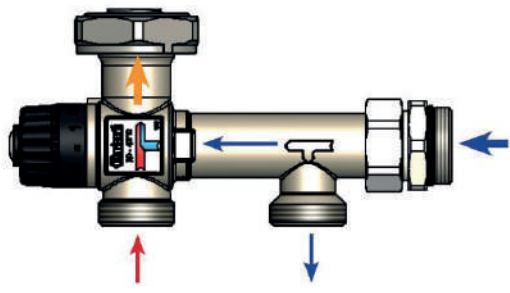

The knob is equipped with an anti-tamper mechanism which makes the rotation difficult, thus avoiding undesired set changes. The mechanism can be released with a screwdriver, slightly loosening the locking screw

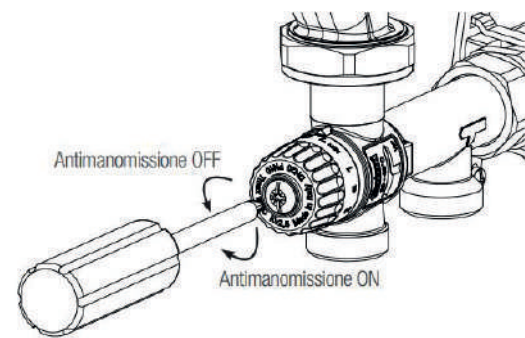

FIRST SYSTEM START UP

The fixed point temperature value can be set with the knob before installing the group or, after the installation, exclusively with the SYSTEM COLD. To set a temperature value different from the factory one, proceed as follows:

1. The graduated scale on the knob corresponds to the temperature values shown in the table.

20-55 °C	
MIN	20 °C
1	28 °C
2	35 °C
3	41 °C
4	47 °C
5	51 °C
MAX	55 °C
	MIN

2. With a screwdriver, slightly loosen the locking screw, holding the knob with your hand.

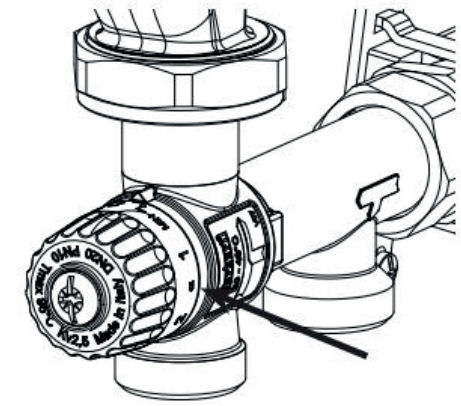

3. Set a mixed water temperature value slightly lower than the design temperature. Activate the generator and wait until it reaches its design working temperature (higher than the valve setting). Activate the group pump. Wait until the mixed water temperature gets stable. Read its value on the flow temperature gauge.

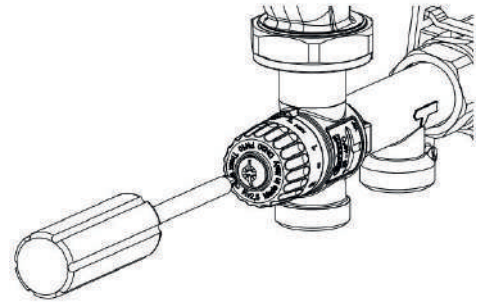

4. Counterclockwise rotate step by step the knob to increase the temperature. Then wait until the temperature gets stable. Read its value on the flow temperature gauge. Proceed in the same way until the design flow temperature is reached.

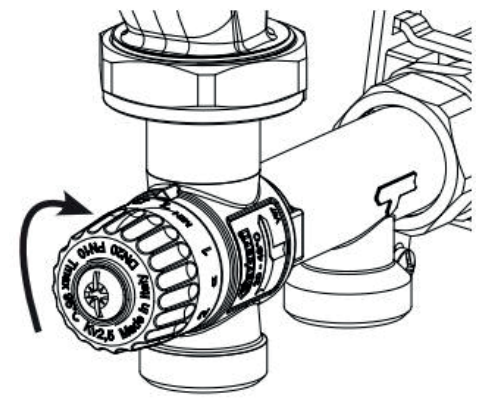

5. When the desired temperature is reached, close the locking screw, holding the knob with your hand.

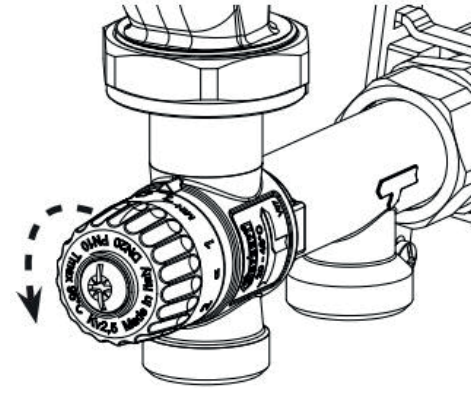

NEXT SETTING

If later a change should be needed in the valve setting, proceed as follows.

Case 1: temperature lower than the current setting. Let the system get cold to obtain at least a return

temperature lower than the new valve setting. Follow points 1, 2, 3, 4 and 5.

Case 2: temperature higher than the current setting. In this case, the setting can be carried out also with the system running as well as with the system cold. Follow points 1, 2, 4 and 5.

MANUAL AIR VENT

Use: the manual air vent can be used during system filling or to release air accumulated during normal functioning of the system. It is suggested to operate on the valve when the system is cold.

6500.Q2 FIXED-POINT MIXING AND DISTRIBUTION STATION WITH SAFETY THERMOSTAT, COMPLETE WITH BOX

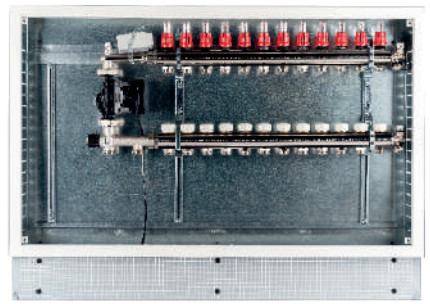

CODE					
6500Q2N100502A	2	1"	211	-	1
6500Q2N100503A	3	1"	211	-	1
6500Q2N100504A	4	1"	211	-	1
6500Q2N100505A	5	1"	211	-	1
6500Q2N100506A	6	1"	211	-	1
6500Q2N100507A	7	1"	211	-	1
6500Q2N100508A	8	1"	211	-	1
6500Q2N100509A	9	1"	211	-	1
6500Q2N100510A	10	1"	211	-	1
6500Q2N100511A	11	1"	211	-	1
6500Q2N100512A	12	1"	211	-	1

6500.Q4 FIXED-POINT MIXING AND DISTRIBUTION STATION WITH SAFETY THERMOSTAT AND 3-WAY HIGH TEMPERATURE KIT, COMPLETE WITH BOX

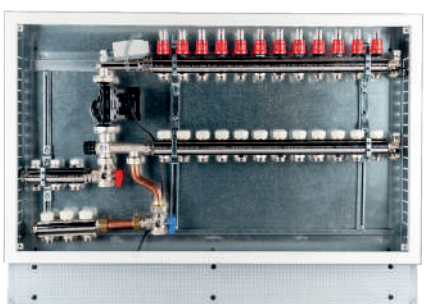

CODE					
6500Q4N100502A	2	1"	211	-	1
6500Q4N100503A	3	1"	211	-	1
6500Q4N100504A	4	1"	211	-	1
6500Q4N100505A	5	1"	211	-	1
6500Q4N100506A	6	1"	211	-	1
6500Q4N100507A	7	1"	211	-	1
6500Q4N100508A	8	1"	211	-	1
6500Q4N100509A	9	1"	211	-	1
6500Q4N100510A	10	1"	211	-	1
6500Q4N100511A	11	1"	211	-	1
6500Q4N100512A	12	1"	211	-	1

2-way version also available.
ART.: 6500.Q3

CODE					
6500Q3N100502A	2	1"	211	-	1
6500Q3N100503A	3	1"	211	-	1
6500Q3N100504A	4	1"	211	-	1
6500Q3N100505A	5	1"	211	-	1
6500Q3N100506A	6	1"	211	-	1
6500Q3N100507A	7	1"	211	-	1
6500Q3N100508A	8	1"	211	-	1
6500Q3N100509A	9	1"	211	-	1
6500Q3N100510A	10	1"	211	-	1
6500Q3N100511A	11	1"	211	-	1
6500Q3N100512A	12	1"	211	-	1

6500.Q5 HIGH TEMPERATURE DISTRIBUTION KIT



CODE				
6500Q5N100502A	2	1"	3/4" EK	-
6500Q5N100503A	3	1"	3/4" EK	-

6500.P8 MIXING UNIT WITHOUT PUMP



CODE	
6500P8N102110H	-

Temperature adjustment range: 20-55°C; Max working temperature: 90°C; Max working pressure: 10 bar; Flow coefficient of the mixing valve only: 3,5 Kv

AC00.80.IT MIXING UNIT METAL CABINET
Fixing kit included



CODE				
AC0080ITR0700V	L=700mm	2-3-4-5-6-7	-	-
AC0080ITR0900V	L=900mm	8-9-10	-	-
AC0080ITR1000V	L=1000mm	11-12	-	-

6500.P4 CONTROL PACK WITH PUMP

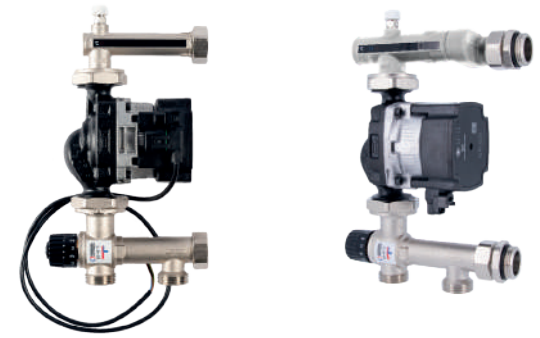

CODE			
6500P4N10211AH	211	Kv 3.5	-
6500P4N10200AH	200-211	Kv 3.5 200	-

Temperature adjustment range: 20-55°C; Max working temperature: 90°C; Max working pressure: 10 bar; Pump: Grundfos UPM3:IP 44; Flow coefficient of the mixing valve only: 3,5 Kv.

6500.Q6 SAFETY THERMOSTAT



CODE	
6500Q6HTERSICH	-

Normally closed with 55 °C setting

6500 LINE

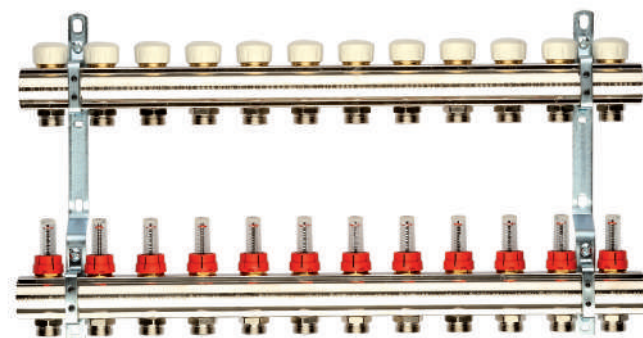











MANIFOLDS FOR RADIANT SYSTEMS WITH 3/4" CONNECTIONS

LINE 6500 manifolds with 3/4" connections are suitable for the realization of underfloor heating and cooling radiant systems. Manifolds are preassembled on brackets. Delivery and return manifolds are available from 1" to 1"1/4. Manifolds can be housed in metal cases and placed in the walls. Manifold components are available for the correct operation of the system: ball valves, air vent valves, charge-discharge valves, flow meters, terminal kits.

ADVANTAGES

- Balancing of each loop
- No unnecessary waste
- High technical comfort
- Bars subjected to stretching heat treatment to avoid breakage due to mechanical stress
- Suitable both for high and low temperature installations

CERTIFICATIONS

COUNTRY	CERTIFICATION	COUNTRY	CERTIFICATION	COUNTRY	CERTIFICATION
					
					

REGULATIONS

- UNI EN ISO 228-1:2003
Threads complies with UNI EN ISO 228-1:2003 law: "Piping thread for coupling not with tightness on the thread"

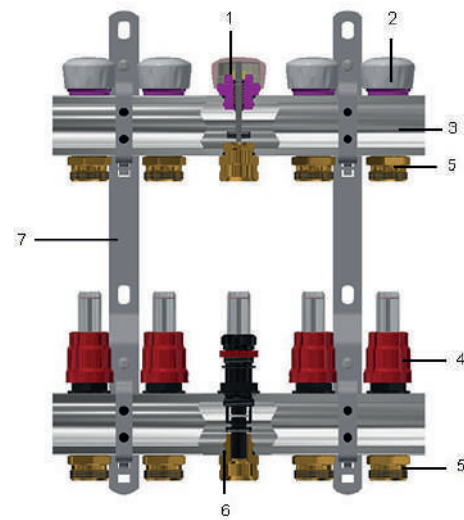

LEGEND	COMPONENTS	MATERIALS
1	Mechanical balancing screw	CW617N - UNI EN 12164
2	Knob	ABS
3	Manifold	CW603 - UNI EN 12164
4	Flow meter	PLASTIC PA66
5	Connecting Nipples	CW617N - UNI EN 12164
6	O-Ring	Elastomer for drinking water
7	Brackets	FE ZNB

FLOWMETER "MEMORY - STOP" FUNCTION

Blocking system of the opening grade of the flowmeter which allows, once the system is reopened, the stopping of the run at its initial setting (project value).



- 1) Set the Flowmeter control to the design value. The control wheel must be removed during this operation.
 - 2) Turn the "Memory stop" ferrule anticlockwise (left-hand thread) to the end of its travel.
 - 3) Put the control wheel back on. The individual circuit can be closed by turning the wheel clockwise. By turning it the other way up to the stop it is possible to reopen the circuit to the set design value. Using the two holes in the control wheel it is possible to seal the Flowmeter so as to prevent tampering with the setting.
- Warning: do NOT use any tools to turn/manipulate the Flowmeter, as to do so could stop it working properly.

MAINTENANCE INSTRUCTIONS

- The glass can be disassembled in order to check its cleanliness, even when the installation is working.
- 1) Close the flow meter turning the ring, but not before than having recorded the installation balancing (l/min)
 - 2) With the help of a hexagonal wrench, unscrew the glass by acting on the hexagonal structure of the glass
 - 3) Clean the glass
 - 4) Re-insert the glass in its original position, balancing again the installation

MECHANICAL BALANCING OF THE INSTALLATION

Flowmeters are located on the supply part of the circuit. Through their adjustment, it is possible to evaluate the theoretic flow of the plumbing installation.

You have to adjust it when the valve is in the back-draft position and completely open.

Given that the flow of each plumbing circuit causes a loose in installation capacity, for each ring of the flow meter is basic that the adjustment are made by hand until you reach flow value in litre/minutes decided by the plan.

POSITION	N° TURNS	KVS (M3/H)
1	1/2	0.09
2	1	0.27
3	1+1/2	0.73
4	2	0.91
5	2+1/2	1.08
6	3	1.26
7	3+1/2	1.41
8	4	1.53
9	4+1/2	1.65
10	5	1.76
11	5+1/2	1.85
12	tutto aperto	1.92

PLUMBING BALANCING PROTECTION AGAINST TAMPERING

The adjustment of the regulators and flow meters can be blocked using buffer caps, eventually leaded.

FLUID DYNAMIC CHARACTERISTICS

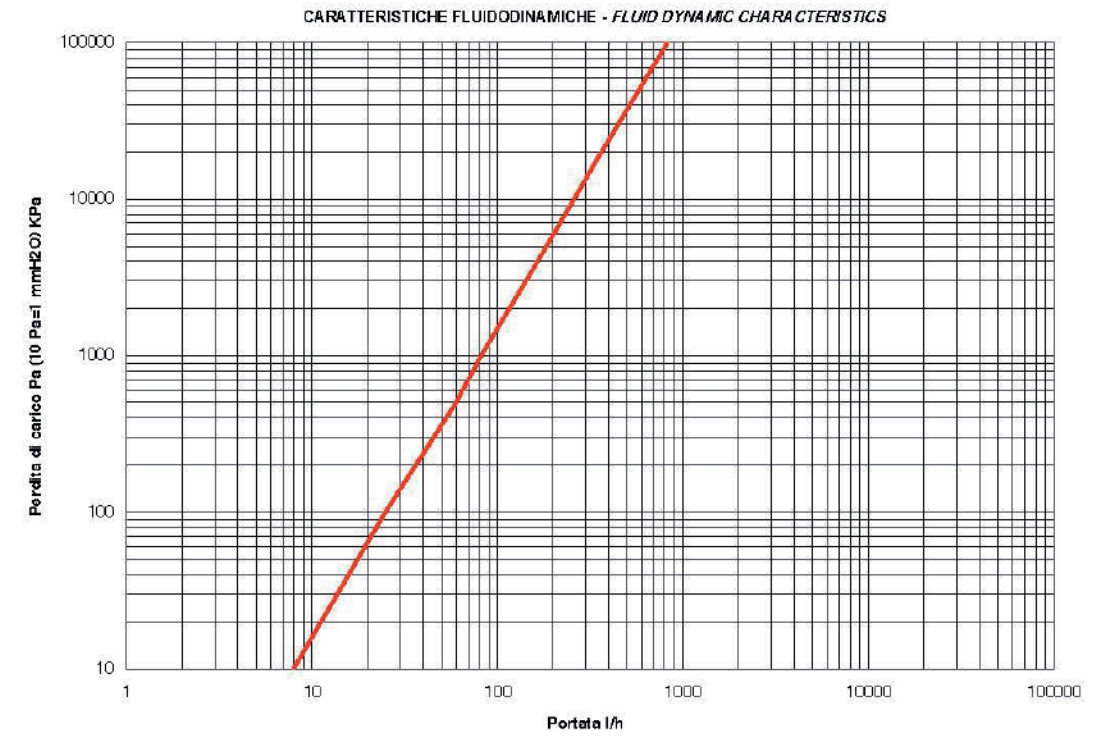

FLOWMETER 0.5 L

DP Pa	DP kpa	Q l/h
10	0.01	8
100	0.1	25
500	0.5	60
1000	1	82
5000	5	185
10000	10	260
20000	20	365
30000	30	450
40000	40	520
50000	50	585
60000	60	640
70000	70	690
80000	80	740
90000	90	785
100000	100	825

COMPONENTS:
6500.71

- 6500.H6 manifold includes:
 - Delivery manifold with flowmeters and nipples
 - Return manifold with shut-off valves arranged for electrothermic control
 - 3/4" Eurocone connections
 - Brackets

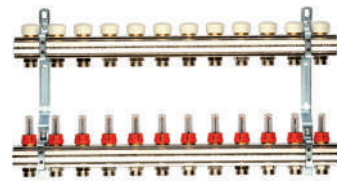

CONNECTIONS:
6500.71

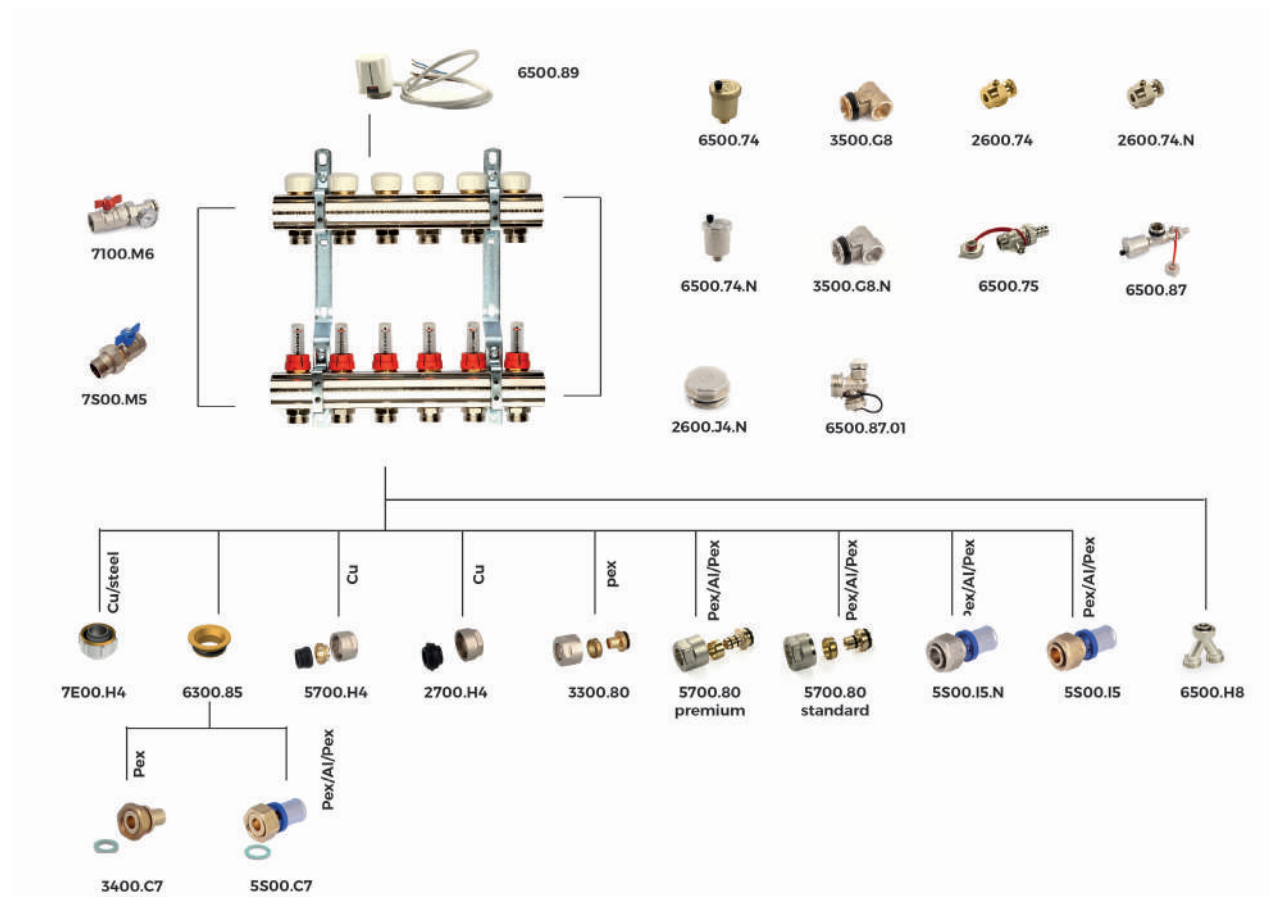

6500.71
DIMENSIONS

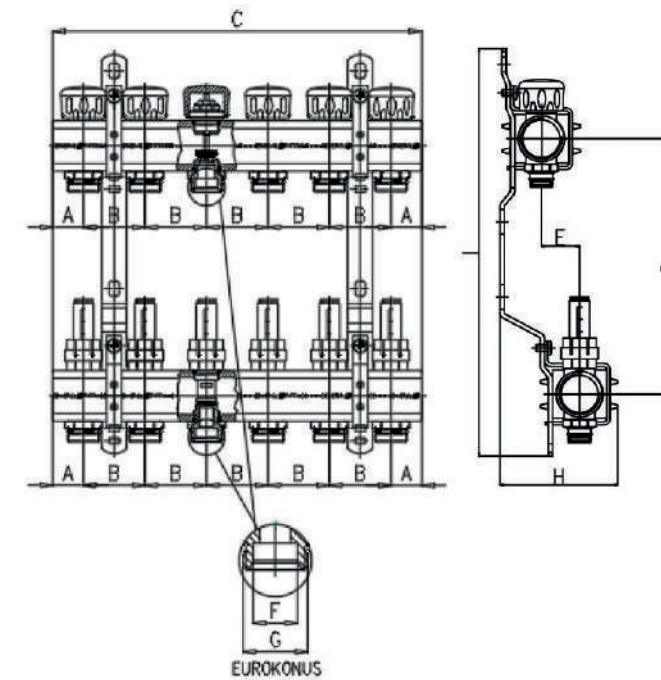

CODE	A	B	C	D	E	F	G	H (STANDARD BRACKET)*	H (OPTIONAL-BRACKET)**	I	WAYS	PIPE DIMENSIONS
650071N100502V	25	50	100	200	31	Ø18,1	3/4"	90	75	324	2	1"-3/4"Ek.
650071N100503V	25	50	150	200	31	Ø18,1	3/4"	90	75	324	3	1"-3/4"Ek.
650071N100504V	25	50	200	200	31	Ø18,1	3/4"	90	75	324	4	1"-3/4"Ek.
650071N100505V	25	50	250	200	31	Ø18,1	3/4"	90	75	324	5	1"-3/4"Ek.
650071N100506V	25	50	300	200	31	Ø18,1	3/4"	90	75	324	6	1"-3/4"Ek.
650071N100507V	25	50	350	200	31	Ø18,1	3/4"	90	75	324	7	1"-3/4"Ek.
650071N100508V	25	50	400	200	31	Ø18,1	3/4"	90	75	324	8	1"-3/4"Ek.
650071N100509V	25	50	450	200	31	Ø18,1	3/4"	90	75	324	9	1"-3/4"Ek.
650071N100510V	25	50	500	200	31	Ø18,1	3/4"	90	75	324	10	1"-3/4"Ek.
650071N100511V	25	50	550	200	31	Ø18,1	3/4"	90	75	324	11	1"-3/4"Ek.
650071N100512V	25	50	600	200	31	Ø18,1	3/4"	90	75	324	12	1"-3/4"Ek.
650071N120502V	30	50	110	200	34	Ø18,1	3/4"	100	85	324	2	1"1/4-3/4"Ek.
650071N120503V	30	50	160	200	34	Ø18,1	3/4"	100	85	324	3	1"1/4-3/4"Ek.
650071N120504V	30	50	240	200	34	Ø18,1	3/4"	100	85	324	4	1"wl/4-3/4"Ek.
650071N120505V	30	50	260	200	34	Ø18,1	3/4"	100	85	324	5	1"1/4-3/4"Ek.
650071N120506V	30	50	310	200	34	Ø18,1	3/4"	100	85	324	6	1"1/4-3/4"Ek.
650071N120507V	30	50	360	200	34	Ø18,1	3/4"	100	85	324	7	1"1/4-3/4"Ek.
650071N120508V	30	50	410	200	34	Ø18,1	3/4"	100	85	324	8	1"1/4-3/4"Ek.
650071N120509V	30	50	460	200	34	Ø18,1	3/4"	100	85	324	9	1"1/4-3/4"Ek.
650071N120510V	30	50	510	200	34	Ø18,1	3/4"	100	85	324	10	1"1/4-3/4"Ek.
650071N120511V	30	50	560	200	34	Ø18,1	3/4"	100	85	324	11	1"1/4-3/4"Ek.
650071N120512V	30	50	610	200	34	Ø18,1	3/4"	100	85	324	12	1"1/4-3/4"Ek.

* standard bracket already assembled (H= 90 for manifolds of 1" ; H=100 for manifolds of 1"1/4) for use with 110 depth case (AC0080I500000A / AC0080I700000A / AC0080I100000A)

** Optional bracket, already present in the package (H= 75 for manifolds of 1" ; H=85 for manifolds of 1"1/4), for use with 90 depth case (AC0080I500090A / AC0080I700090A / AC0080I850090A /AC0080I100090A) and 110 depth case (AC0080I500000A / AC0080I700000A / AC0080I100000A)

**COMPONENTS:
6500.72**

- 6500.H6 manifold includes:
- Delivery manifold with flow meters and nipples
 - Return manifold with shut-off valves arranged for electrothermic control
 - 3/4" Eurocone connections
 - Automatic air vent valves and charge/discharge valves
 - Ball valves with thermometer
 - Brackets

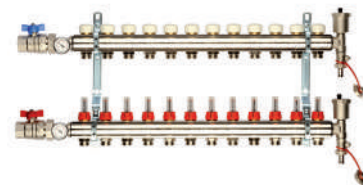

**CONNECTIONS:
6500.72**

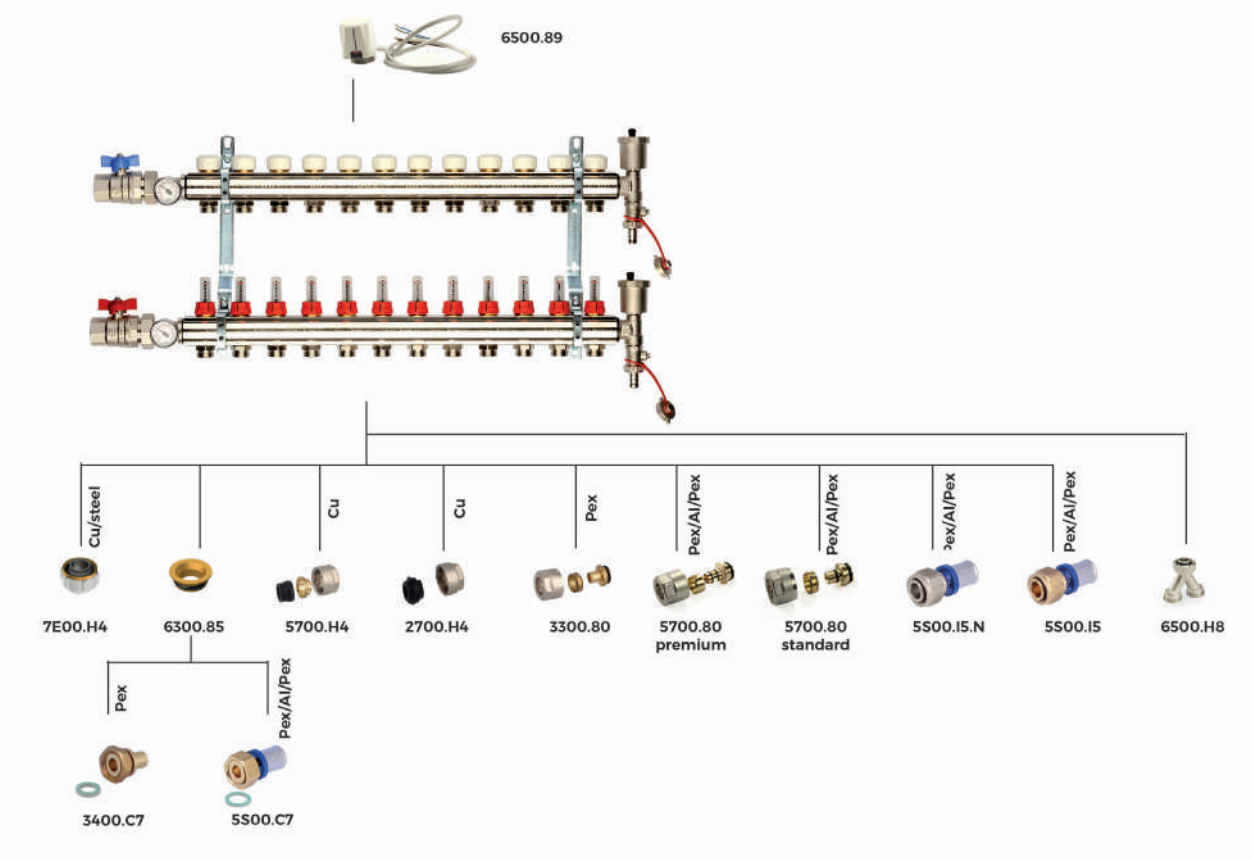

**6500.72:
DIMENSIONS**

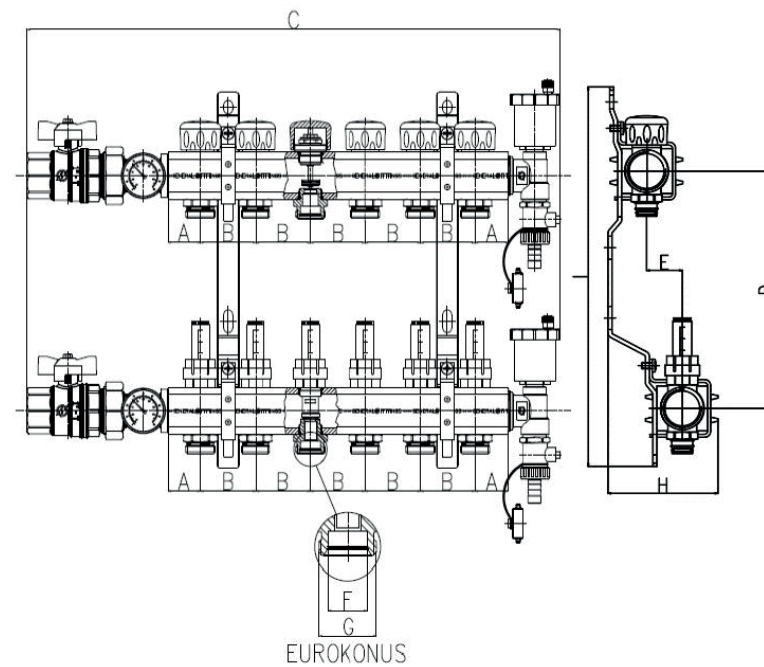

CODE	A	B	C	D	E	F	G	H (STANDARD BRACKET)*	H (OPTIONAL-BRACKET)**	I	WAYS	PIPE DIMENSIONS
650072N100502V	25	50	270	200	31	Ø18,1	3/4"	90	75	324	2	1"-3/4"Ek.
650072N100503V	25	50	320	200	31	Ø18,1	3/4"	90	75	324	3	1"-3/4"Ek.
650072N100504V	25	50	370	200	31	Ø18,1	3/4"	90	75	324	4	1"-3/4"Ek.
650072N100505V	25	50	420	200	31	Ø18,1	3/4"	90	75	324	5	1"-3/4"Ek.
650072N100506V	25	50	470	200	31	Ø18,1	3/4"	90	75	324	6	1"-3/4"Ek.
650072N100507V	25	50	520	200	31	Ø18,1	3/4"	90	75	324	7	1"-3/4"Ek.
650072N100508V	25	50	570	200	31	Ø18,1	3/4"	90	75	324	8	1"-3/4"Ek.
650072N100509V	25	50	620	200	31	Ø18,1	3/4"	90	75	324	9	1"-3/4"Ek.
650072N100510V	25	50	670	200	31	Ø18,1	3/4"	90	75	324	10	1"-3/4"Ek.
650072N100511V	25	50	720	200	31	Ø18,1	3/4"	90	75	324	11	1"-3/4"Ek.
650072N100512V	25	50	770	200	31	Ø18,1	3/4"	90	75	324	12	1"-3/4"Ek.
650072N100513V	25	50	770	200	31	Ø18,1	3/4"	90	75	324	13	1"-3/4"Ek.
650072N120502V	30	50	295	200	34	Ø18,1	3/4"	100	85	324	2	1"1/4-3/4"Ek.
650072N120503V	30	50	345	200	34	Ø18,1	3/4"	100	85	324	3	1"1/4-3/4"Ek.
650072N120504V	30	50	395	200	34	Ø18,1	3/4"	100	85	324	4	1"1/4-3/4"Ek.
650072N120505V	30	50	445	200	34	Ø18,1	3/4"	100	85	324	5	1"1/4-3/4"Ek.
650072N120506V	30	50	495	200	34	Ø18,1	3/4"	100	85	324	6	1"1/4-3/4"Ek.
650072N120507V	30	50	545	200	34	Ø18,1	3/4"	100	85	324	7	1"1/4-3/4"Ek.
650072N120508V	30	50	595	200	34	Ø18,1	3/4"	100	85	324	8	1"1/4-3/4"Ek.
650072N120509V	30	50	645	200	34	Ø18,1	3/4"	100	85	324	9	1"1/4-3/4"Ek.
650072N120510V	30	50	695	200	34	Ø18,1	3/4"	100	85	324	10	1"1/4-3/4"Ek.
650072N120511V	30	50	745	200	34	Ø18,1	3/4"	100	85	324	11	1"1/4-3/4"Ek.
650072N120512V	30	50	795	200	34	Ø18,1	3/4"	100	85	324	12	1"1/4-3/4"Ek.

* standard bracket already assembled (H= 90 for manifolds of 1" ; H=100 for manifolds of 1"1/4) for use with 110 depth case (AC0080I500000A / AC0080I700000A / AC0080I100000A)

** Optional bracket, already present in the package (H= 75 for manifolds of 1" ; H=85 for manifolds of 1"1/4), for use with 90 depth case (AC0080I500090A / AC0080I700090A / AC0080I850090A / AC0080I100090A) and 110 depth case (AC0080I500000A / AC0080I700000A / AC0080I100000A)

**COMPONENTS
6500.H6**

- 6500.H6 manifold includes:
- Delivery manifold with flow meters and nipples
 - Return manifold with shut-off valves arranged for electrothermic control
 - 3/4" Eurocone connections
 - Air vent valves and charge/discharge valves
 - Brackets

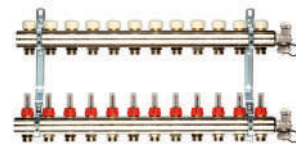

**CONNECTIONS
6500.H6**

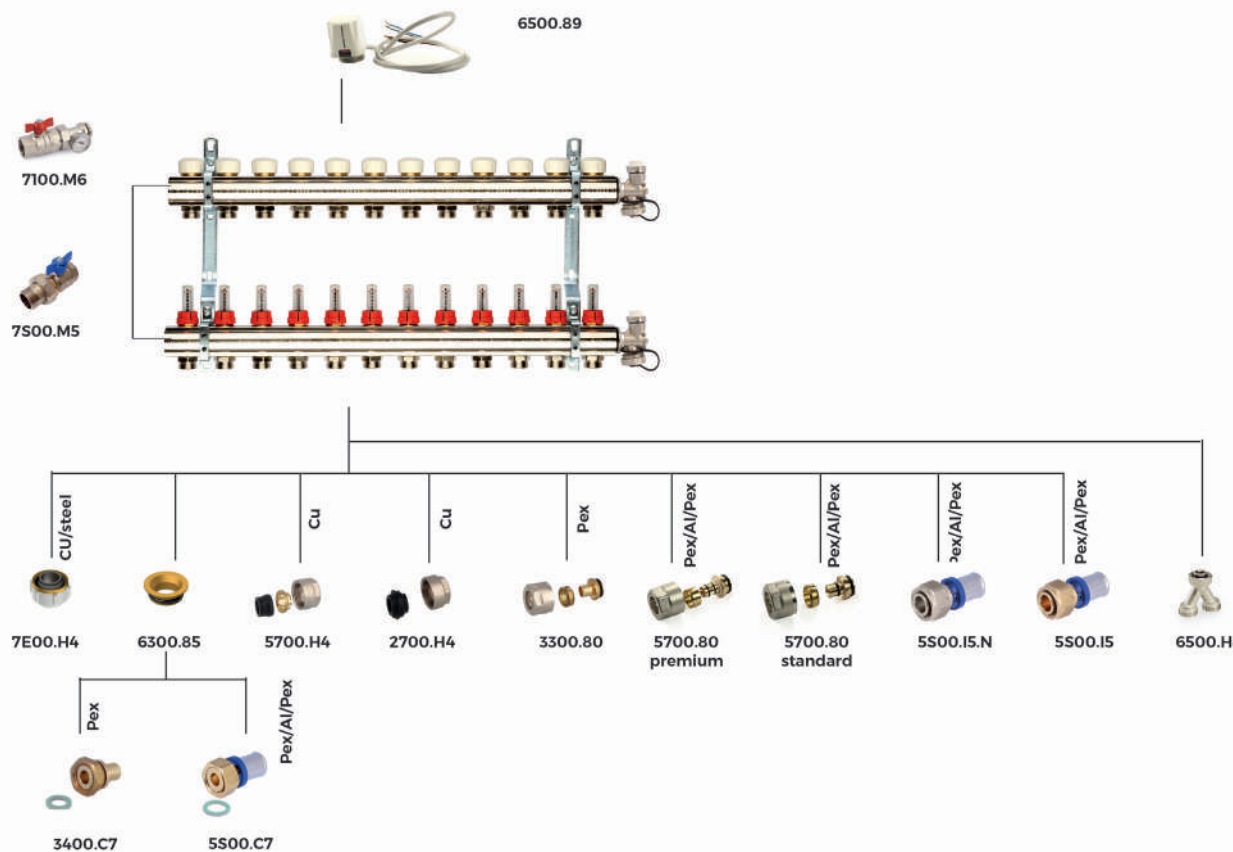

**DIMENSIONS
6500.H6**

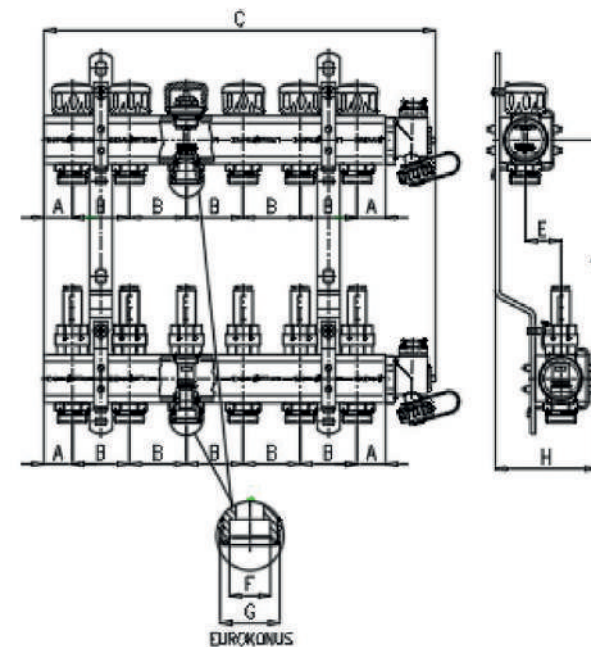

CODICE	V	B	C	D	E	F	G	H (STANDARD BRACKET)*	H (OPTIONAL-BRACKET)**	I	WAYS	PIPE DIMENSIONS
6500H6N100502V	25	50	141.5	200	31	Ø18,1	3/4"	90	75	324	2	1"-3/4"Ek.
6500H6N100503V	25	50	191.5	200	31	Ø18,1	3/4"	90	75	324	3	1"-3/4"Ek.
6500H6N100504V	25	50	241.5	200	31	Ø18,1	3/4"	90	75	324	4	1"-3/4"Ek.
6500H6N100505V	25	50	291.5	200	31	Ø18,1	3/4"	90	75	324	5	1"-3/4"Ek.
6500H6N100506V	25	50	341.5	200	31	Ø18,1	3/4"	90	75	324	6	1"-3/4"Ek.
6500H6N100507V	25	50	391.5	200	31	Ø18,1	3/4"	90	75	324	7	1"-3/4"Ek.
6500H6N100508V	25	50	441.5	200	31	Ø18,1	3/4"	90	75	324	8	1"-3/4"Ek.
6500H6N100509V	25	50	491.5	200	31	Ø18,1	3/4"	90	75	324	9	1"-3/4"Ek.
6500H6N100510V	25	50	541.5	200	31	Ø18,1	3/4"	90	75	324	10	1"-3/4"Ek.
6500H6N100511V	25	50	591.5	200	31	Ø18,1	3/4"	90	75	324	11	1"-3/4"Ek.
6500H6N100512V	25	50	641.5	200	31	Ø18,1	3/4"	90	75	324	12	1"-3/4"Ek.
6500H6N100513V	25	50	641.5	200	31	Ø18,1	3/4"	90	75	324	13	1"-3/4"Ek.

* standard bracket already assembled (H= 90 for manifolds of 1" ; H=100 for manifolds of 1"1/4) for use with 110 depth case (AC0080I500000A / AC0080I700000A / AC0080I100000A)
 ** Optional bracket, already present in the package (H= 75 for manifolds of 1" ; H=85 for manifolds of 1"1/4), for use with 90 depth case (AC0080I550090A / AC0080I700090A / AC0080I850090A /AC0080I100090A) and 110 depth case (AC0080I500000A / AC0080I700000A / AC0080I100000A)

6500.71 DISTRIBUTION MANIFOLD WITH BALANCING FLOW METERS

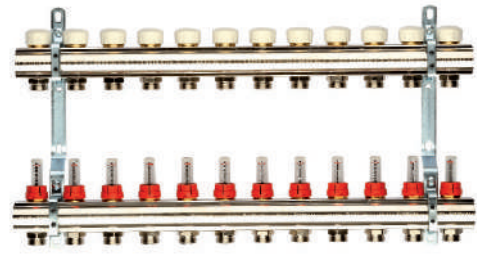

CODE					
650071N100503V	3	1"	200	-	-
650071N100504V	4	1"	200	-	-
650071N100505V	5	1"	200	-	-
650071N100506V	6	1"	200	-	-
650071N100507V	7	1"	200	-	-
650071N100508V	8	1"	200	-	-
650071N100509V	9	1"	200	-	-
650071N100510V	10	1"	200	-	-
650071N100511V	11	1"	200	-	-
650071N100512V	12	1"	200	-	-
650071N120502V	2	1"1/4	200	-	-
650071N120503V	3	1"1/4	200	-	-
650071N120504V	4	1"1/4	200	-	-
650071N120505V	5	1"1/4	200	-	-
650071N120506V	6	1"1/4	200	-	-
650071N120507V	7	1"1/4	200	-	-
650071N120508V	8	1"1/4	200	-	-
650071N120509V	9	1"1/4	200	-	-
650071N120510V	10	1"1/4	200	-	-
650071N120511V	11	1"1/4	200	-	-
650071N120512V	12	1"1/4	200	-	-

6500.72 DISTRIBUTION MANIFOLD WITH BALANCING FLOW METERS AND VALVES

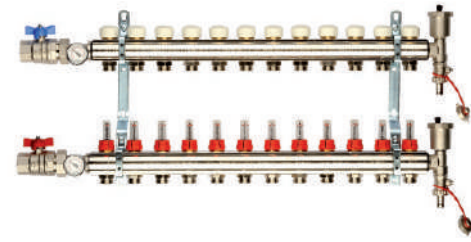

CODE					
650072N100502V	2	1"	200	-	-
650072N100503V	3	1"	200	-	-
650072N100504V	4	1"	200	-	-
650072N100505V	5	1"	200	-	-
650072N100506V	6	1"	200	-	-
650072N100507V	7	1"	200	-	-
650072N100508V	8	1"	200	-	-
650072N100509V	9	1"	200	-	-
650072N100510V	10	1"	200	-	-
650072N100511V	11	1"	200	-	-
650072N100512V	12	1"	200	-	-
650072N100513V	13	1"	200	-	-
650072N120502V	2	1"1/4	200	-	-
650072N120503V	3	1"1/4	200	-	-
650072N120504V	4	1"1/4	200	-	-
650072N120505V	5	1"1/4	200	-	-
650072N120506V	6	1"1/4	200	-	-
650072N120507V	7	1"1/4	200	-	-
650072N120508V	8	1"1/4	200	-	-
650072N120509V	9	1"1/4	200	-	-
650072N120510V	10	1"1/4	200	-	-
650072N120511V	11	1"1/4	200	-	-
650072N120512V	12	1"1/4	200	-	-

6500.H6 DISTRIBUTION MANIFOLD WITH FLOW METERS AND TERMINAL

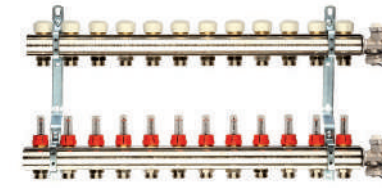

CODE					
6500H6N100502V	2	3/4"	1"	-	-
6500H6N100503V	3	3/4"	1"	-	-
6500H6N100504V	4	3/4"	1"	-	-
6500H6N100505V	5	3/4"	1"	-	-
6500H6N100506V	6	3/4"	1"	-	-
6500H6N100507V	7	3/4"	1"	-	-
6500H6N100508V	8	3/4"	1"	-	-
6500H6N100509V	9	3/4"	1"	-	-
6500H6N100510V	10	3/4"	1"	-	-
6500H6N100511V	11	3/4"	1"	-	-
6500H6N100512V	12	3/4"	1"	-	-
6500H6N100513V	13	3/4"	1"	-	-
6500H6N120502V	2	3/4"	1"1/4	-	-
6500H6N120503V	3	3/4"	1"1/4	-	-
6500H6N120504V	4	3/4"	1"1/4	-	-
6500H6N120505V	5	3/4"	1"1/4	-	-
6500H6N120506V	6	3/4"	1"1/4	-	-
6500H6N120507V	7	3/4"	1"1/4	-	-
6500H6N120508V	8	3/4"	1"1/4	-	-
6500H6N120509V	9	3/4"	1"1/4	-	-
6500H6N120510V	10	3/4"	1"1/4	-	-
6500H6N120511V	11	3/4"	1"1/4	-	-
6500H6N120512V	12	3/4"	1"1/4	-	-

6500.H8 EUROKONUS NICKEL-PLATED SPLITTER



CODE			
6500H8N050000V	3/4"	-	50

5Q00.80 NICKEL-PLATED NUT, OLIVE AND INSERT EUROCONE FOR MULTILAYER PIPE



CODE				
5Q0080N051116V	11.6x3/4"	1.5	10	100

6500.87 AUTOMATIC MANIFOLD TERMINAL KIT



CODE	Ø	◆	◻
650087N100000V	1"	-	12
650087N120000V	1 1/4"	-	10

6500.87.N MANUAL MANIFOLD TERMINATION KIT



CODE	Ø	◆	◻
650087N100001V	1"	2	30
650087N120001V	1 1/4"	-	-

7100.M6 BALL VALVE WITH THERMOMETER WITH BUTTERFLY



CODE	Ø	i	◆	◻
7100M6N10102BV	1"	Blue	2	12
7100M6N10102RV	1"	Red	2	12
7100M6N12122BV	1 1/4"	Blue	2	12
7100M6N12122RV	1 1/4"	Red	2	12

7100.M8 M/F ANGLE WITH NUT AND TAIL WITH BUTTERFLY



CODE	Ø	◆	◻
7100M8N101000V	1"	5	15

7S00.M5 M/F MANIFOLD WITH BUTTERFLY



CODE	Ø	i	◆	◻
7S00M5N1010B2V	1"	Blue	5	20
7S00M5N1010R2V	1"	Red	5	20
7S00M5N1212B2V	1 1/4"	Blue	-	10
7S00M5N1212R2V	1 1/4"	Red	-	10

7100.M5 M/F STRAIGHT UNION BALL VALVE WITH BUTTERFLY



CODE	Ø	i	◆	◻
7100M5N1212B2V	1 1/4"	Blue	-	10
7100M5N1212R2V	1 1/4"	Red	-	10

AC00.70 MANIFOLD INSULATION



CODE	Ø	↕	◆	◻
AC0070G061200V	1"	12	-	-
AC0070G071200V	1 1/4"	12	-	-

3300.80 NICKEL-PLATED NUT, OLIVE AND INSERT EUROCONE FOR PE-X PIPE



CODE	Ø	✱	◆	◻
330080N051214V	3/4"x14	2.0	10	100
330080N051620V	3/4"x16	2.0	10	100
330080N051720V	3/4"x17	2.0	10	100
330080N052020V	3/4"x20	2.0	10	100

5700.80 STANDARD NICKEL-PLATED NUT, OLIVE AND INSERT EUROCONE FOR MULTILAYER PIPE



CODE	Ø	→←	◇	◻
570080N051620V	3/4"x16	2.0	10	100

6500.89 ELECTROTHERMIC CONTROL



CODE	i	◇	◻
650089H2300W4V	230V 4 fili	-	50
650089H2300W2V	230V 2 fili	-	50

Electrothermic control (nc) with 2 wires or 4 wires and 230V; grade of protection

AC00.80 CASE METAL CABINET



CODE	Ø	→	◇	◻
AC0080I550090V	550x600x90	2-3-4-5	-	-
AC0080I700090V	700x600x90	6-7-8-9	-	-
AC0080I850090V	850x600x90	10-11	-	-
AC0080I100090V	1000x600x90	12	-	-
AC0080I500000V	500x700x110	2-3-4-5	-	-
AC0080I700000V	700x700x110	6-7-8-9	-	-
AC0080I100000V	1000x700x110	10-11-12-13	-	-

5S00.15.N NICKEL-PLATED STRAIGHT FITTING WITH LOOSE NUT AND EUROCONE



6500.35.AD STICKER THERMOMETER



CODE	Ø	→←	◇	◻
5S00I5N051620V	3/4" EKx16	2.0	10	100
5S00I5N051820V	3/4" EKx18	2.0	10	100
5S00I5N052020V	3/4" EKx20	2.0	10	80
5S00I5N052022V	3/4" EKx20	2.25	10	80

CODE	Ø	↕	◇	◻
650035HADTERMV	+32°C ÷ +42°C	-	-	-



AIR TREATMENT

VARMO CLIMA:
dehumidifiers

Dehumidifiers

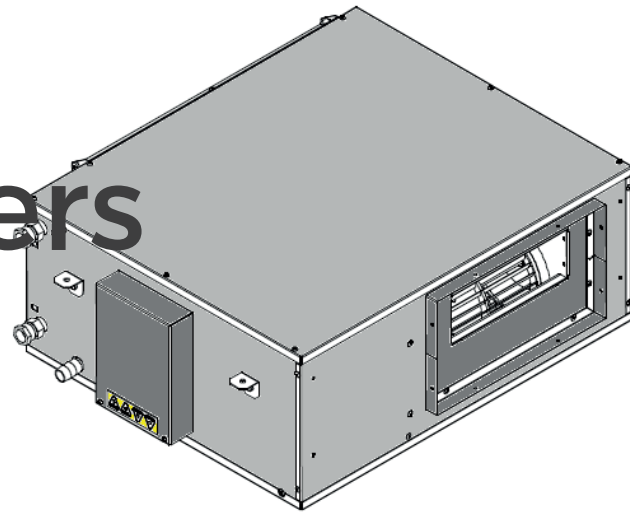

VARMO CLIMA offers a series of wall-mounted or ceiling-mounted dehumidifiers capable of constantly dehumidifying and reciprocating indoor air, thus ensuring a healthy environment and high physical well-being. VARMO CLIMA also offers air handling units that in the winter season provide for increasing the air temperature and humidity through the succession of preheating, humidification and postheating. In the summer season, on the other hand, they provide for decreasing the air temperature and humidity through the succession of cooling and postheating.

FEATURES

- Controls humidity: a dehumidifier is the perfect solution against excess humidity in the home
- Prevents mold: mold is one of the most common effects of excess humidity in the home. Placing a dehumidifier in the room will reduce the moisture in the air and the formation of mold
- Improves well-being: excess humidity in the home can have unpleasant effects on health. It can make people feel cold and smell musty, make them cough and sneeze, or aggravate pre-existing allergy symptoms. A dehumidifier helps reduce excess humidity, making the air more pleasant to breathe.
- Protects your belongings: dehumidifiers protect your belongings against moisture damage. Clothes, books and some foods can stay in better condition longer without getting moldy or creating a musty smell.

**GEOMETRIC FEATURES
WALL-MOUNTED
DEHUMIDIFIERS**

GEOMETRIC FEATURES	
Height	573 mm
Width	722 mm
Depth	202 mm
MDF panel dimensions (H x W x D)	790 x 630 x 18 mm
Weight	34 kg

**PHYSICAL FEATURES
WALL MOUNTED
DEHUMIDIFIERS**

PHYSICAL FEATURES	6I00DIH24L000H	6I00DIH24RD00H	
(26°C - 65% RH - water inlet 15°C)	-	Dehumidification	Integration
Condensing humidity (l/day)	24	25.5	
Power supply (V/ph/Hz)	230/1/50		
Rated electrical power (W)	360	410	420
Rated current (A)	2	-	
Nominal air flow rate (m3/h)	200	300	
Fan type	3-speed centrifugal	dual-suction centrifugal with directly coupled motor	
Refrigerant (g of R134a)	260	450	
Compressor	Hermetic, single-cylinder, reciprocating with bipolar asynchronous motor		
Nominal cooling water flow rate (l/h)	240	180	
Hydraulic connections	2 x ½" Gas F	2 x ¾" GAS M euroconus	
Noise level (dB)	37	-	
Intake air temperature (°C)	15 ÷ 32		
Battery	-	Copper tubes and aluminum fins with "hydrophilic" treatment	
Air filter	-	G3 class	
Available head (Pa)	-	24	45
Pre-cooling water flow rate (l/h)	-	180	
Total water flow rate (l/h)	-	220	290
Water pressure drop (kPa)	-	12	15

AMOUNT OF WATER
EXTRACTED - DEHUMIDIFIERS
WALL-MOUNTED

AMOUNT OF WATER EXTRACTED (DAILY) 6100DIH24L000H					AMOUNT OF WATER EXTRACTED (DAILY) 6100DIH24RD00H				
T WATER	T = 26°C U.R. = 55%	T = 26°C U.R. = 65%	T = 24°C U.R. = 55%	T = 24°C U.R. = 65%	T WATER	T = 26°C U.R. = 55%	T = 26°C U.R. = 65%	T = 24°C U.R. = 55%	T = 24°C U.R. = 65%
21°C	11,6 l/g	12,6 l/g	9,5 l/g	12,2 l/g	21°C	14,4 l/g	18,7 l/g	11,4 l/g	15,8 l/g
18°C	13,8 l/g	17,9 l/g	10,6 l/g	15,2 l/g	18°C	15,4 l/g	20,5 l/g	12,7 l/g	17,1 l/g
15°C	16,7 l/g	24,0 l/g	14,3 l/g	18,0 l/g	15°C	16,6 l/g	25,5 l/g	13,8 l/g	18,1 l/g

GEOMETRICAL FEATURES OF
SUSPENDED CEILING DEHUMIDIFIERS

GEOMETRICAL FEATURES	
Height	247 mm
Width	668 mm
Depth	550 mm
Weight	34 kg

PHYSICAL FEATURES DEHUMIDIFIERS COUNTERTOP

PHYSICAL FEATURES	6100DCH26L000H	6100DCH26RD00H	
(26°C - 65% RH - water inlet 15°C)	-	Dehumidification	Integration
Condensing humidity (l/day)	26.5	25.5	
Power supply (V/ph/Hz)	230/1/50		
Rated electrical power (W)	360	410	420
Rated current (A)	2	-	
Nominal air flow rate (m ³ /h)	200	300	
Fan type	3-speed centrifugal	dual-suction centrifugal with directly coupled motor	
Refrigerant (g of R134a)	260	450	
Compressor	Hermetic, single-cylinder, reciprocating with bipolar asynchronous motor		
Nominal cooling water flow rate (l/h)	240	180	
Hydraulic connections	2 x ½" Gas F	2 x ¾" GAS M euroconus	
Noise level (dB)	38	46 ÷ 51,2	
Intake air temperature (°C)	15 ÷ 32		
Battery	-	Copper tubes and aluminum fins with "hydrophilic" treatment	
Air filter	-	classe G3	
Available head (Pa)	-	24	45
Pre-cooling water flow rate (l/h)	-	180	
Total water flow rate (l/h)	-	220	290
Water pressure drop (kPa)	-	12	15

AMOUNT OF WATER EXTRACTED (DAILY) 6I00DCH26L000H					AMOUNT OF WATER EXTRACTED (DAILY) 6I00DCH26RD00H				
T WATER	T = 26°C U.R. = 55%	T = 26°C U.R. = 65%	T = 24°C U.R. = 55%	T = 24°C U.R. = 65%	T WATER	T = 26°C U.R. = 55%	T = 26°C U.R. = 65%	T = 24°C U.R. = 55%	T = 24°C U.R. = 65%
21°C	10,4 l/g	14,8 l/g	14,3 l/g	17,6 l/g	21°C	14,4 l/g	18,7 l/g	11,4 l/g	15,8 l/g
18°C	13,4 l/g	18,8 l/g	17,8 l/g	21,7 l/g	18°C	15,4 l/g	20,5 l/g	12,7 l/g	17,1 l/g
15°C	16,9 l/g	23,1 l/g	21,0 l/g	26,6 l/g	15°C	16,6 l/g	25,5 l/g	13,8 l/g	18,1 l/g

6100.DI IN-WALL DEHUMIDIFIER

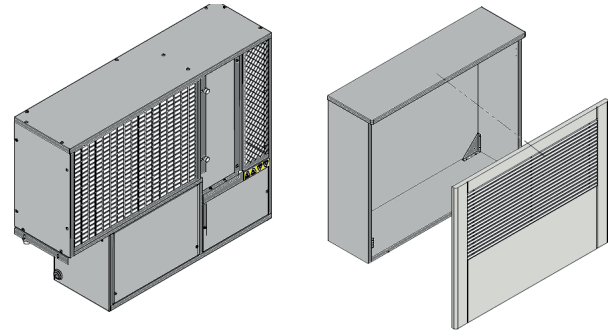

CODE	Ø	i	Refrigerator power
6100DIH24L000H	619x760x209mm	Built-in wall dehumidifier with grid + frame without integration	695W
6100DIH24RD00H	619x760x209mm	Recessed wall dehumidifier with grille + frame	1645W
6100DIH24CC00H	-	Counter case for RDMPA machine	
6100DIH24GR00H	-	Front panel for counter case	
6100DIH24MA00H	-	Only machine 695W without counter case	
6100DIH24SC00H	-	Only machine 1645W with integration	

6100.DC COUNTERTOP DEHUMIDIFIER

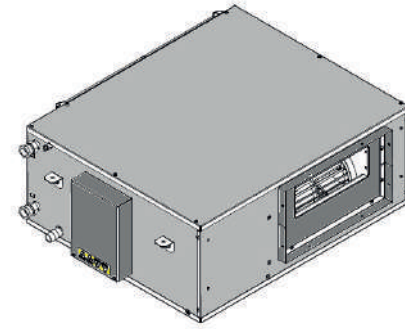

CODE	Ø	Potenza frigo
6100DCH26L000H	247x550x630mm	740W
6100DCH26RD00H	247x550x630mm	1690W

Condensing humidity (26°C - 65% Rh) 25.50 l/day. 230V (1ph/50Hz) power supply. Possibility of ducting via supply plenum.

6100.UM SUMMER/WINTER CHRONOTHERMOSTAT



CODE	◇	◻
6100UMH309000H	-	1

24-hour chronothermostat. Three temperature regimes per season. Battery power supply (2x1.5V). vacation, party, pause and total shutdown function. Working range 5-39°C. Integrated summer/winter switching. NTC temperature sensor. IP30 degree of protection. Fixed antifreeze 5°C. Possibility of connection to a telephone programmer. Wall mounting. Suitable for room temperature control, piloting a thermal servo control, electric heater, cooling unit, or activating a burner.

Sales conditions and warranty applied by General Fittings S.p.A. to products in the Varmo catalogue

1. DEFINITIONS

"Vendor" means General Fittings S.p.A., Tax Code. 01613110178, Vat Cod., 03448140172, based in Gussago (BS), 25064, via Golgi n. 73/75; "Buyer" means the person, company or company to whom the Seller's Offer, Order Confirmation and invoice are addressed.

2. SCOPE OF APPLICATION AND ADDITIONAL CLAUSES

These general conditions apply to every single Order or Contract for the supply of goods and services rendered by the Seller and prevail over any general conditions of the Purchaser.

Any additional or different contractual clauses with respect to the provisions of these general conditions are valid only if they result from a written agreement.

3. CATALOGS AND PRICE LISTS

The articles, measures, characteristics and prices of the products indicated in the catalogs and the price lists of the Seller are purely indicative. They can be changed without notice. They are binding only after the conclusion of the Contract when they are indicated in the Order Confirmation.

4. OFFERS AND CONCLUSION OF THE CONTRACT

The Offers and Proposals of the Seller are not binding; they expire after 30 days from the date of issue. Following the Order of the Purchaser, the Seller will send the Purchaser an Order Confirmation indicating the prices and details of the supply. The Contract will end with the receipt by the Seller of the acceptance of the Order Confirmation signed by the Purchaser.

5. CERTIFICATIONS

Any product certifications and / or declarations of conformity must be requested by the Purchaser in the Request for Quotation and, in any case, before the conclusion of the Contract.

6. TERMS OF DELIVERY

The expected or agreed delivery terms are purely indicative and they are likely to change during the preparation stages of the products. The Seller is not liable for damages caused by delays in delivery. The mere delay in delivery cannot constitute grounds for termination of the contract.

7. DELIVERY

The agreed place of delivery is at the production unit indicated in the offer and where not specified is Ex Works (Incoterms 2010).

Delivery takes place with the assignment of the goods to the carrier or forwarder. Transport, insurance and other costs associated with shipping are to be paid by the Purchaser.

No responsibility is attributable to the Seller, nor for losses or damages of any kind caused by stowage, loading and / or transport.

No responsibility is attributable to the Seller even when the Purchaser provides for transportation of the goods with his own vehicle or with carriers chosen by him.

The Purchaser is responsible for inspecting the incoming goods.

The packaging is not included in the price and it is in charge of the Purchaser.

The return of products is possible after written authorization only.

8. LACK OF DATA FOR SHIPMENT

The Purchaser who has not provided detailed references for shipping must collect the goods no later than one week from the notification of goods ready. Otherwise the Seller will have the right to invoice the goods, to stock the material and to charge the Buyer for the related costs.

9. WITHDRAWAL

The Seller has the right to withdraw from the Contract if there are any facts (such as merely an example: difficulty in accessing the inputs, increase in the price of raw materials, organizational problems, etc.) which, at the unquestionable judgment of the Seller, are such do not allow the useful continuation of the contractual relationship. In this case, the Buyer is not entitled to any compensation or indemnity.

10. COMPLAINTS

Complaints and any claims must be made in writing no later than 8 (eight) days of receipt of goods and addressed to the headquarters of the Seller using templates to be asked to service@generalfittings.it mail.

Failing this, the products will be deemed compliant with the concluded Contract and the Seller will not be liable for errors, faults or lack of quality. The filing of a claim does not allow the Purchaser to omit or delay payment of the price.

11. WARRANTIES AND 10-YEAR WARRANTY EXTENSION

The warranty is provided in accordance with the law (1490 of the Italian Civil Code and following), provided that the product is installed in a workmanlike manner, according to the assembly and testing methods / instructions provided for by law and / or by the Seller. For extended warranty see following pages.

12. PRODUCT CIVIL LIABILITY

To open the product liability claim, the Seller must receive all information, including images of defective products in the area in which they were installed and one or more defective samples in support.

The complaint must be made using the templates to be asked to service@generalfittings.it mail.

The Seller must be given the opportunity, within 8 days from the date of the alleged damage and in any case before any intervention to remedy the situation, to inspect the condition of the places.

The prescription times for the product liability, the seller complies with the national and EU laws.

13. LIABILITY LIMITATIONS

The Purchaser, through the Order, is responsible for compliance with all the safety and legal requirements related to the product purchased.

The Seller is not responsible for any direct or indirect damage to persons or property caused by improper use of the supplied product. In any case, the Seller is not responsible for any direct or indirect damage to persons or property if the assumptions provided for in art. 11 of the present general conditions, point 2. Conditions) or if one of the hypotheses provided for by art. 11 of the present general conditions, point 3. Decadences).

14. CLAIM OF INVOICES

The Seller's invoices may be contested only in writing within and no later than 30 days from receipt of the same. Failing this, they are considered fully accepted.

15. PAYMENTS, FACULTY OF SUSPENSION OF SUPPLIES, DEADLINE FROM THE BENEFIT OF THE TERM, PAYMENT GUARANTEES

Payments must be made at the Seller's premises according to the terms and conditions indicated in the Order Confirmation.

The agreed payment methods do not change any changes to the place for payment. If the Purchaser does not make the payments within the agreed terms, the Seller will have the right to charge the commercial

interest for late payment (Legislative Decree No. 231/2002) and to obtain reimbursement of expenses incurred for the effects and remittances outstanding as well as the legal recovery costs, without the need for a default notice.

Any delay or irregularity in payments will give the Seller the right to discontinue supplies, even if not directly connected to the payments affected by delay.

If a deferred payment is envisaged, any delay or irregularity in payments will result in the automatic forfeiture of the Buyer from the benefit of the term, with immediate payment of the entire amount due by the Purchaser also in relation to supplies not directly connected to the payments affected by delay or irregularity.

The Seller has the right to change the payment terms for future supplies and request payment advances.

The Seller, even during the execution of the Contract, can request suitable payment guarantees. In the event that the required guarantees are not granted, the Seller may suspend the execution of the contract.

16. APPLICABLE LAW, JURISDICTION, COMPETENT COURT

The law and the Italian jurisdiction apply to the relationship between Seller and Purchaser; for any disputes exclusive jurisdiction is the Court of Brescia (Italy).

EXTENSION OF DECANTAL CONVENTIONAL WARRANTY

11.1. Subject

All products of the Seller are guaranteed for 10 (ten) years from the date of issue of the invoice with which the same products are supplied.

The guarantee provided only concerns the pure and simple replacement of products or of particular components of the same which are defective due to a manufacturing defect such that the products cannot be used for ordinary use to which they may be destined. Any guarantee for expenses and / or damages caused by the defective product to things and / or people is excluded from the guarantee given here.

The normal obsolescence of the products or of particular elements of the same is excluded from the guarantee given here.

The following products are excluded from the guarantee given here: engines, pipes, gaskets, ...

Products and particular components of the same ones sold by the Seller but not produced by the same are excluded from the warranty provided here.

The guarantee provided here is operative throughout the Italian and European national territory.

The guarantee given here is valid only if the Purchaser has sent the Seller express acceptance of these general conditions by signing them at the bottom. Failing this, the Seller will be required to provide exclusively the guarantee according to the current laws.

It is the responsibility of those who intend to activate the warranty to prove the defect of the manufacture of the product, the fact that it was not recognizable upon receipt of the product (see article 10 of these general conditions), the invoice of the Seller with which the product was supplied and the signing of the present general conditions by the Purchaser.

In the absence of even one of these elements, the Seller will not be required to provide the conventional guarantee.

In order to be replaced, defective products must be returned to the Seller in advance.

The return of defective products, in any case, must always be agreed in advance with the Seller.

The warranty is to be considered valid only in compliance with the conditions indicated in the following point 11.2.

The guarantee lapses in the cases indicated in the following point 11.3.

The external Laying and Protection Indications

indicated in the following point 11.4 must always be observed.

11.2. Conditions

- Pipes and fittings must be installed according to the instructions contained in the installation manual, defined in the general catalog of the Seller.
- No tampering or alteration of the products must have occurred after the production period, even only due to accidental causes.
- The operating conditions (temperatures, pressures, nature of liquids, tensioning) must fall within the parameters indicated in the installation manual, defined in the general catalog of the Seller.
- The items object of request must expressly bring the trademarks.

11.3. Decadency

- Failure or incorrect observance, even partial, of the installation instructions provided by the manufacturer.
- Missed or incorrect observance of the rules of art or of the specific rules of good technique.
- Use of deteriorated and therefore unsuitable materials: pipes and fittings that have been aged or scratched, crushed, etc..
- Use of materials not supplied by the Seller (pipes and fittings).
- Plant built and developed by a non-specialized or unlicensed thermosanitary installer.
- Failure to comply with the instructions for Laying and Protection against external corrosion referred to in point 11.4 below.
- Lack of plant test and related documentation.

11.4. Laying and protection against external corrosion

In order to avoid failure of the brass products, it is advisable to isolate the fittings in an inspectable box or in any case protect them with appropriate materials. For their protection, anti-corrosion and waterproof materials must be used, that inhibit corrosion from possible chemical agents, and materials resistant to heat and aging.

These installation instructions must be applied in conjunction with the assembly instructions defined for each individual product range and duly shown in the Seller's catalog.

11.5. Consumer rights

It is specified that the Consumer is the owner of the rights established by the Consumer Code (Legislative Decree No. 206/2005) in Articles 128 et seq. And that this Conventional Warranty is without prejudice to such rights.

Date ...

The Purchaser

(Stamp and Signature)

Pursuant to and for the effects of art. 1341 and 1342 of the Civil Code, as applicable, the Purchaser declares to approve specifically the following articles of the general conditions of sale applied by General Fittings S.p.A.

2. Scope of application and additional clauses;

6. Terms of delivery;

9. Withdrawal;

10. Complaints;

11. Warranty and 10-year warranty extension;

13 Limitations of liability;

14. Dispute of invoices;

15. Payments, right to suspend deliveries, forfeiture of the term benefit, payment guarantees;

16. Applicable law, jurisdiction and competent court.

Date

The Purchaser

(Stamp and Signature)