



FEB 

Data sheet **LINE 7E00**

Valves and lockshields for radiator

Contents

DESCRIPTION	3
ADVANTAGES	3
FIELDS OF APPLICATION	3
VALVE: COMPONENTS AND MATERIALS	4
LOCKSHIELD: COMPONENTS AND MATERIALS	6
PRESSURE DROP DIAGRAM	8
REGULATIONS	9
CERTIFICATIONS	9

LINE 7E00





Valves and lockshields for radiator

FEB



DESCRIPTION

Valves are devices for the interception of fluids such as hot and cold water in heating and cooling systems. The valves are available in all figures, with female or Euroconus threaded connections. In addition to the inlet valve to the heating body, a lockshield valve with interception and regulation functions should be installed at the outlet. General Fittings lockshields have the center distance equal to the corresponding inlet valve. The smooth and rounded lines of 7E00 valves are aesthetically pleasing, thanks to the development of an interlocking knob. On a technical level the 7E00 series has a double sealing closure, which is granting a greater safety. The closure of the valve is in fact guaranteed by an O-Ring as well as Metal-to-Metal tightening.

ADVANTAGES

-  Wide range
-  Double sealing: O-Ring as well as Metal-to-Metal tightening for increased security
-  Handle without visible screw
-  Raw materials complying with UBA LIST



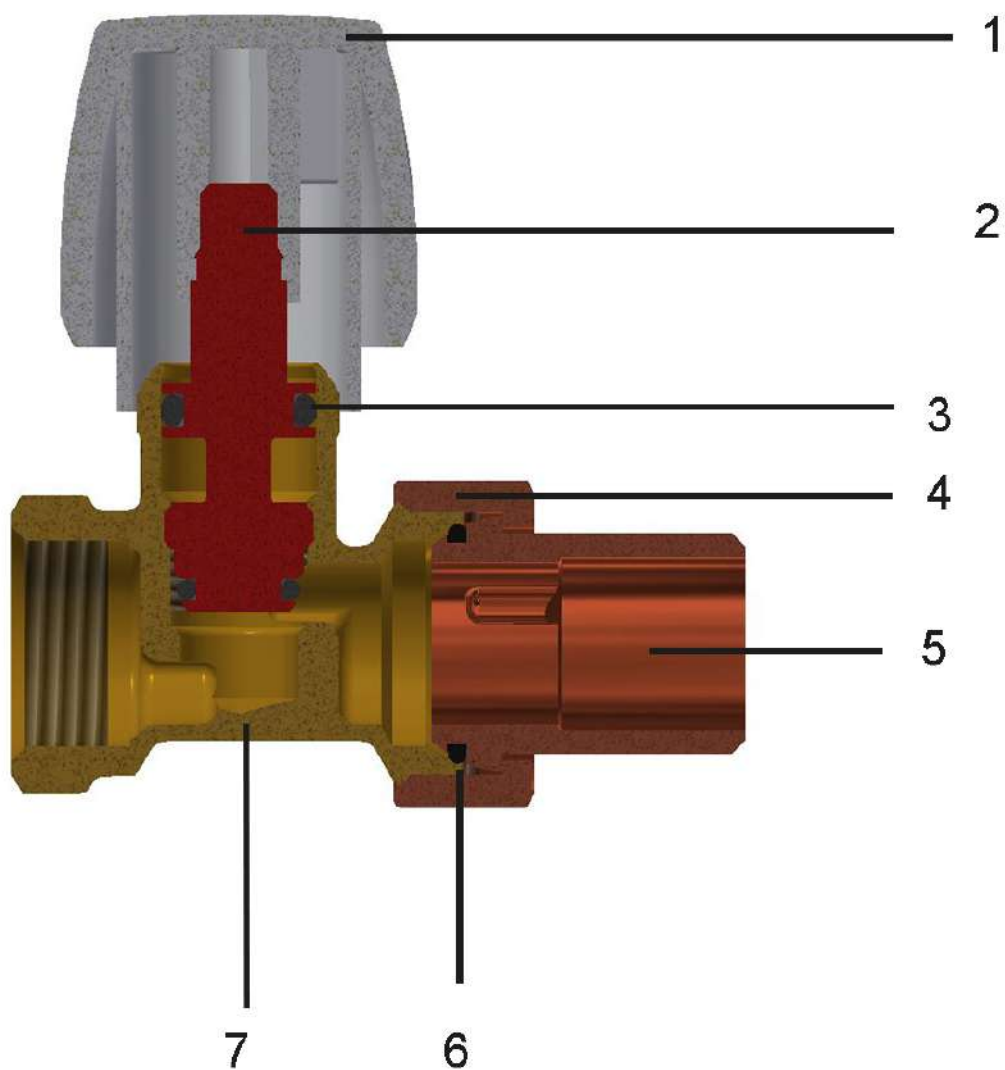

FIELDS OF APPLICATION

APPLICATIONS	T. min	T. max	Max. pressure	Diff. press.
 radiators	-20°C	+100°C	10 bar	1 bar
-20°C: only with antifreeze liquid (glycol) in % max of 30%				

VALVE: COMPONENTS AND MATERIALS







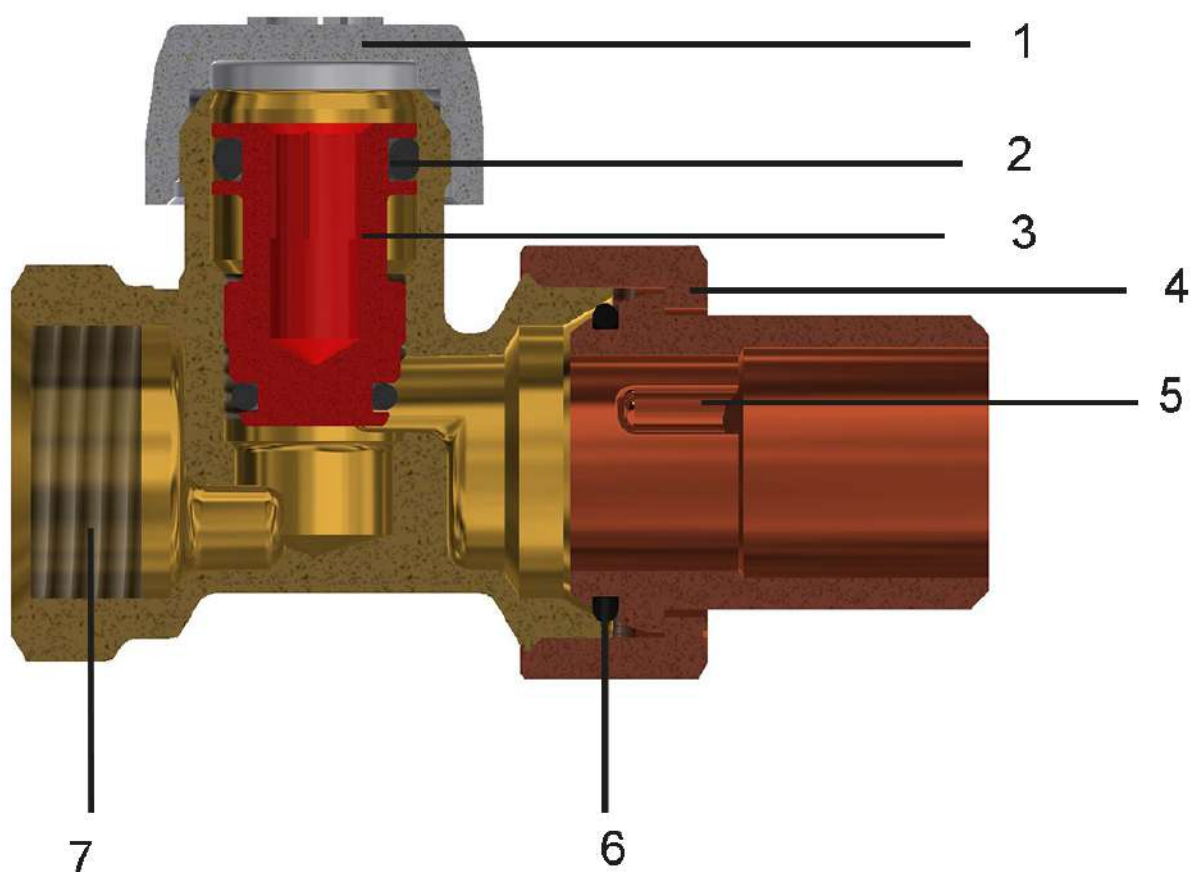

LEGEND		COMPONENTS	MATERIALS
	1	Handle	ABS white RAL 9010
	2	Stem	Brass CW617N - UNI EN 12164
	3	Stem O-Ring	Elastomer

LEGEND		COMPONENTS	MATERIALS
	4	Nut	Brass CW617N - UNI EN 12165
	5	Pipe union	Brass CW617N - UNI EN 12164
	6	O-Ring pipe union	Elastomer
	7	Body	Brass CW617N - UNI EN 12165

LOCKSHIELD: COMPONENTS AND MATERIALS



LEGEND		COMPONENTS	MATERIALS
	1	Handle	ABS white RAL 9010
	2	Stem O-Ring	Elastomer
	3	Shutter	Brass CW617N - UNI EN 12164

LEGEND		COMPONENTS	MATERIALS
	4	Nut	Brass CW617N - UNI EN 12165
	5	Pipe union	Brass CW617N - UNI EN 12164
	6	O-Ring pipe union	Elastomer
	7	Body	Brass CW617N - UNI EN 12165

PRESSURE DROP DIAGRAM

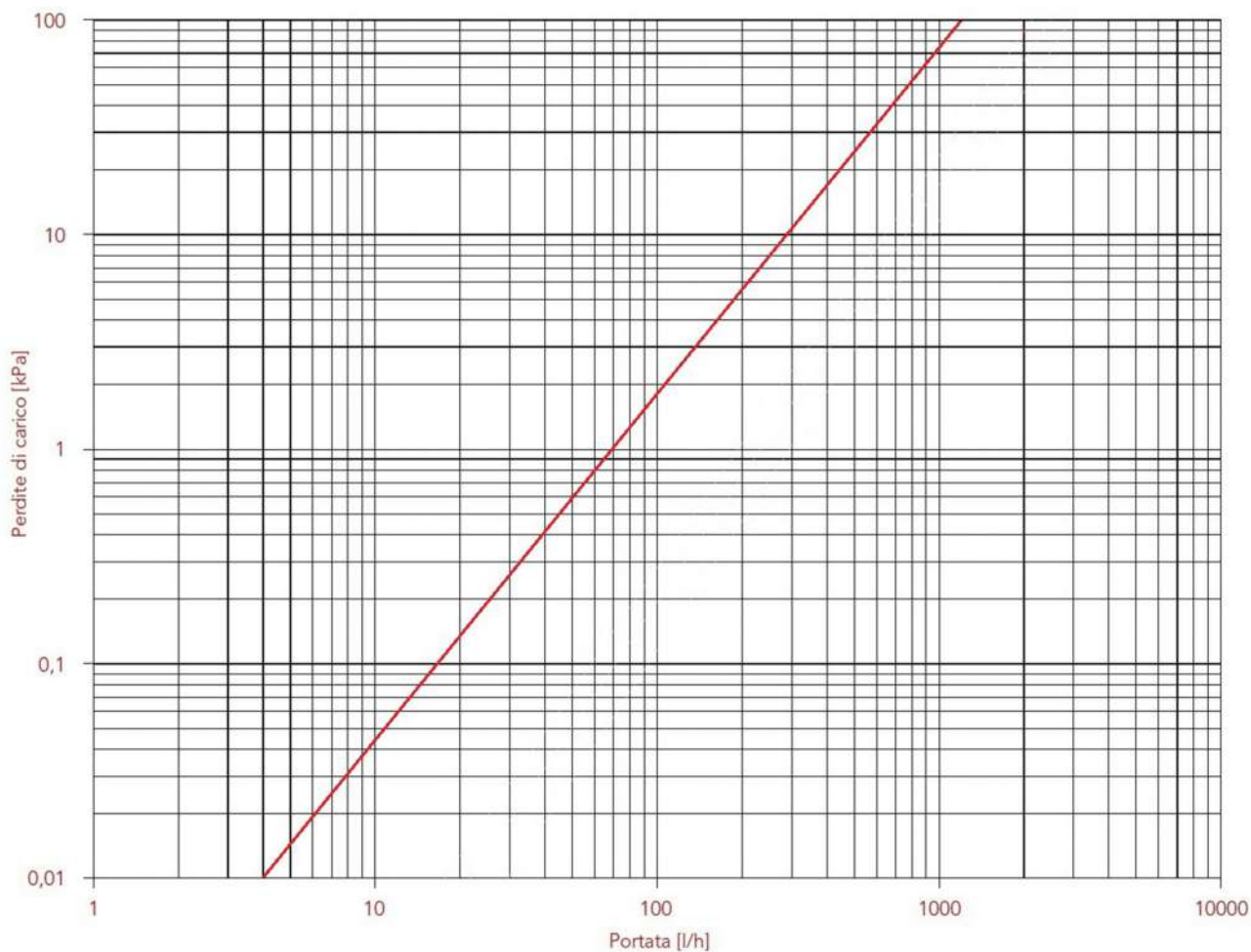

Kv 1.25

REGULATIONS

- UN EN ISO 228-1

Threads complies with UNI EN ISO 228-1:2003 law: "Piping thread for coupling not with thightness on the thread"

CERTIFICATIONS

COUNTRY	CERTIFICATION	COUNTRY	CERTIFICATION	COUNTRY	CERTIFICATION
					
					



GENERAL FITTINGS SPA

Via Golgi 73/75, 25064 Gussago (BS) - ITALY

te. +39 030 3739017

www.generalfittings.it