



# KRATOS

---

Data sheet LINE 4500

Compression fittings with female nut

---

# Contents

|                          |   |
|--------------------------|---|
| DESCRIPTION              | 3 |
| ADVANTAGES               | 3 |
| FIELDS OF APPLICATION    | 4 |
| CLOSING COUPLES          | 4 |
| COMPONENTS AND MATERIALS | 5 |
| SUITABLE PIPES           | 5 |
| REGULATIONS              | 6 |
| CERTIFICATIONS           | 6 |
| ASSEMBLY INSTRUCTIONS    | 7 |

LINE 4500

Compression fittings with female  
nut**KRATOS**



## DESCRIPTION

Compression fittings with female nut for Polyethylene pipe [LINE 4500] are suitable for the supply of drinking water, for irrigation installation (PEBD), sanitary systems and in the gas fuels conveying and distribution (LDPE-PEHD). They are also suitable for any kind of sanitary installation such as domestic, commercial, industry and farming and with any type of non-corrosive fluid.

## ADVANTAGES

- Complete range
- Suitable both for drinking water and gas
- Quick and easy installation
- Raw materials complying with UBA LIST

## FIELDS OF APPLICATION

| APPLICATIONS  |                | T. min. | T. max | T. of the system | Max. pressure |
|---|----------------|---------|--------|------------------|---------------|
|  | drinking water | -20°C   | +80°C  | -20°C/+40°C      | 16 bar        |
|  | irrigation     | -20°C   | +80°C  | -20°C/+40°C      | 16 bar        |
|  | gas            | -20°C   | +40°C  | -20°C/+40°C      | 10 bar        |

Pipe + fitting system with reference working temperature 20 °C

PE80-12,5 bar water

PE100-16 bar water

PE80-4 bar gas

PE100-10 bar gas

for temperatures from 20 °C up to 40 °C (for water application), use the following pressure reduction factors:

30°C multiply by 0,87





40°C multiply by 0,74

## CLOSING COUPLES

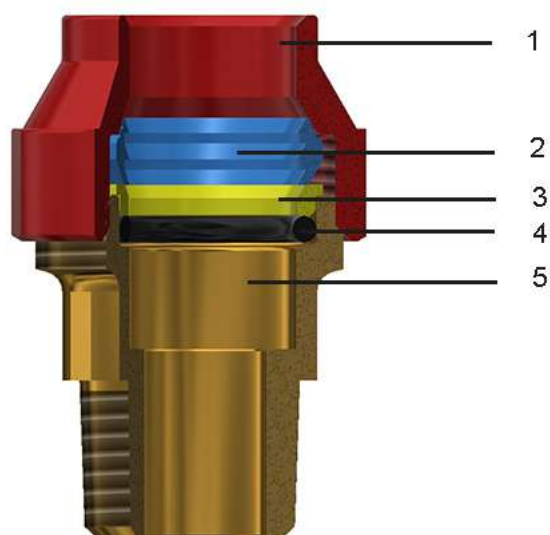
| ∅    | Torque (Nm) |
|------|-------------|
| ∅ 20 | 25          |
| ∅ 25 | 34          |
| ∅ 32 | 44          |
| ∅ 40 | 55          |
| ∅ 50 | 60          |
| ∅ 63 | 130         |

## COMPONENTS AND MATERIALS



| LEGEND  |   | COMPONENTS | MATERIALS   |
|---|---|------------|---|
|  | 1 | Nut        | Brass CW617N - UNI EN 12165                       |
|  | 2 | Olive      | Brass CW617N - UNI EN 12164                       |
|  | 3 | Flat ring  | Brass CW617N - UNI EN 12164                       |
|  | 4 | O-Ring     | Elastomer for drinking water (except for Germany) |
|  | 5 | Body       | Brass CW617N - UNI EN 12165                       |

## SUITABLE PIPES

Polyethylene pipes.

## REGULATIONS

- UNI EN 12201-3

Fittings comply with UNI EN 12201-3 law: "Plastic piping systems for water supply".

- UNI EN 10226-1

Threads comply with UNI EN 10226-1 law: "Piping thread for coupling on the thread".

- D.M. 174 (06/04/2004)

Raw materials used are of high quality and comply with the Ministerial Decree N°174 dated 06/04/2004 concerning the materials and the items used in fixed installations for water collection, treatment and supply.

- UNI EN 1254-3

Fittings comply with UNI EN 1254-3 law: "Sanitary fittings for plastic pipes with compression ends".

- Comply with 4MS, UBA List (BC group), DIN 50930/6 Dir. 2011/65/UE, 6C attachment III (RhOSII)

- Comply with DVGW DW335-B4 (P)

- Comply DVGW G5600-1 (P)

## CERTIFICATIONS

| COUNTRY   | CERTIFICATION   | COUNTRY   | CERTIFICATION   | COUNTRY   | CERTIFICATION   |
|---|---|---|---|---|---|
|  |  |  |  |  |  |
|  |  |  |  |  |  |
|  |  |  |  |   |   |

## ASSEMBLY INSTRUCTIONS

Mark and cut the pipe perpendicularly to its axis using an appropriate pipe-cutting tool [code TT50.00] or a saw with fine springs. The pipe has to be marked in order to let it sort out at the end of its seat once inserted in the fitting and before screwing the nut. The pipe has to be fettled to avoid O-Ring damages. Remove possible residual burr.

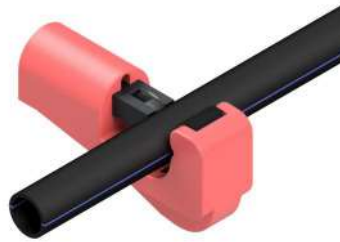

Insert the components on the pipe according to sequence that follows: nut, cut olive (external surface marks have to be directed forward the nut and not forward the fitting), compression ring and gasket (and at the end the sleeve, where expected)



Place the pipe and the components in the fitting, blocking manually the system with the nut screwing. Close the nut using a fixed spanner or a suitable tool giving a screwing coupling as shown in the table [previous page]



Check the nut closing after a seal and pipe adjustment period [24h]. N.B. if the fittings are used for gas, before installing the pipe in the fitting, position the appropriate reinforcement part (supplied only on customer request).







GENERAL FITTINGS SPA

Via Golgi 73/75, 25064 Gussago (BS) - ITALY

te. +39 030 3739017

[www.generalfittings.it](http://www.generalfittings.it)